

The DNA Storage Channel: Capacity and Error Probability Bounds

Nir Weinberger and Neri Merhav

The Viterbi Faculty of Electrical and Computer Engineering

Technion - Israel Institute of Technology

Technion City, Haifa 3200004, Israel

{nirwein@, merhav@ee}.technion.ac.il

Abstract

The DNA storage channel is considered, in which M Deoxyribonucleic acid (DNA) molecules comprising each codeword, are stored without order, then sampled N times with replacement, and the sequenced over a discrete memoryless channel. For a constant coverage depth M/N and molecule length scaling $\Theta(\log M)$, lower (achievability) and upper (converse) bounds on the capacity of the channel, as well as a lower (achievability) bound on the reliability function of the channel are provided. Both the lower and upper bounds on the capacity generalize a bound which was previously known to hold only for the binary symmetric sequencing channel, and only under certain restrictions on the molecule length scaling and the crossover probability parameters. When specified to binary symmetric sequencing channel, these restrictions are completely removed for the lower bound and are significantly relaxed for the upper bound. The lower bound on the reliability function is achieved under a universal decoder, and reveals that the dominant error event is that of *outage* – the event in which the capacity of the channel induced by the DNA molecule sampling operation does not support the target rate.

Index Terms

Asymmetric channels, channel capacity, data storage, DNA storage, outage, permutation channel, reliability function, state-dependent channel, universal decoding.

CONTENTS

I	Introduction	3
I-A	Known Results	4
I-B	Contributions	5
I-C	Other Related Work	8
I-D	Outline	8
II	Problem Formulation	9
II-A	Notation Conventions	9
II-B	Formulation of the DNA Storage Channel	10
III	Lower Bounds	13
III-A	A Lower Bound on the Capacity	14
III-B	A Lower Bound on the Reliability Function	15
IV	An Upper Bound on Capacity	19
V	Modulo-Additive Sequencing Channels	25
VI	A Numerical Example	26
VII	Summary and Open Problems	27
Appendix A: Proofs of Lower Bounds		29
A-A	Preliminaries: Sampling Type Classes	30
A-B	Preliminaries: The DNA Channel as a Mixture of Binomial Channels	33
A-C	A Universal Decoder for the DNA Channel	35
A-D	Random-Coding Error Probability Analysis for a Given Q^{N+1}	37
A-E	Proof of Theorem 8	43
A-F	Proof of Theorem 9	47
Appendix B: Proof of Theorem 10		47
B-A	A Brief Review of Typical Sets	48
B-B	The Molecule Distance Function and its Implications	49
B-B1	Probability of a Typical Set Conditioned on Close v.s. Far Inputs	50
B-B2	Equivocation of a Permutation for Far Inputs	53
B-B3	Common Input Mutual Information Deficit for Close Inputs	57

B-C	Structural Properties of Capacity Achieving Codebooks	64
B-D	Upper Bound on the Mutual Information	66
B-D1	Fixed Composition Molecules and Given Q^{N+1}	67
B-D2	Fixed Composition Molecules and Random Q^{N+1}	75
B-D3	General Composition Molecules	78
Appendix C: Auxiliary Results and Proofs		80
C-A	Symmetry of Binomial Extensions of Symmetric DMCs	80
C-B	Proof of Proposition 13	91
C-C	Mutual Information of K DMC Uses with i.i.d. v.s. Fixed Composition Inputs	94
Appendix D: Computational Aspects of the Bounds		96
References		97

I. INTRODUCTION

In this paper, we establish new lower and upper bounds on the capacity and error probability of coded storage systems based on Deoxyribonucleic acid (DNA) molecules medium, where in some regime of the system parameters, those bounds coincide and provide the capacity of the channel. In principle, since each DNA molecule is comprised of two complementary strands of four nucleotides (Adenine, Cytosine, Guanine, and Thymine), it is equivalent to a sequence of a four-letter alphabet sequence for the purpose of encoding information. However, as explained in [20], current technology is only capable of synthesizing relatively short strands of DNA – sequences of one or two hundred nucleotides. Thus, in practical systems, the stored information is comprised of a large number of DNA molecules which are stored in a pool and cannot be spatially ordered. Hence, unlike ordinary channel coding, in which a codeword is a single sequence of symbols, the DNA codeword is an unordered multiset of short sequences of symbols.

DNA-based storage systems are prone to various of impairments. After synthesizing molecules based on the encoded data, individual molecules are either duplicated or completely erased, in a process called Polymerase Chain Reaction (PCR) amplification. Later on, when the information is read, molecules are sampled from the amplified pool in a random manner, without the possibility to choose a specific molecule. Each chosen molecule is then sequenced to obtain the four-letter alphabet sequence that it encoded.

In accordance, DNA storage systems suffer from impairments both on a molecule level and on a symbol level: In the former, this amounts to duplications or erasures, resulting from the synthesis and the amplification or the sampling process. In the latter, this results in either substitutions, deletions or insertions, resulting from the synthesis and sequencing operations. In [20], a detailed characterization of the impairments of DNA storage systems was provided, and the parameters were estimated based on data sets obtained from the experimental

systems. The conclusion of this survey reinforced the important role of error-correcting codes in DNA storage systems. It thus naturally raised the question of the fundamental limits on the rates of such systems, most importantly, their *capacity*.

In order to characterize the capacity of the DNA storage channel, Shomorony and Heckel [40] have proposed a distilled mathematical model, which both captures the major impairments of the DNA storage channel, on the one hand, and which is reasonably tractable to analyze, on the other hand. The encoded message is synthesized to a pool of M molecules, each of length L symbols. Each symbol is chosen from a given finite alphabet, where an alphabet of size four is the natural choice. When the message is read, each of the molecules is sampled a random number of times, and then sequenced, to obtain the multiset of output molecules. The sequencing operation is modeled as a discrete memoryless channel (DMC) operating on the sampled molecules. The decoder decides on the message based on the sequencing of the sampled molecules. Hence, the non-standard aspects of this model are the loss of order information of the DNA molecules, and their possible duplication or erasure by the sampling mechanism. We mention that this basic model does not include deletions and insertions during the sequencing operation of a given molecule. The (storage) capacity C is then defined as the ratio between then number of messages that can be reliably stored to the total of ML symbols, and it was studied for a few specific variants of the basic model.

A. Known Results

In [40], two settings were considered. First, the model in which the number of samples of each molecule is i.i.d., and the sequencing is perfect (noiseless). This basic model reveals that the length of the molecule must scale as $L = \beta \log M$ for some $\beta \geq 1$, and then capacity is $C = (1 - \mathbb{P}[\text{erasure}])(1 - 1/\beta)$ [40, Theorem 1], where $\mathbb{P}[\text{erasure}]$ is the probability that a molecule is not sampled at all. Compared to a standard erasure channel whose capacity is $C = 1 - \mathbb{P}[\text{erasure}]$, the multiplying term $(1 - 1/\beta)$ can be attributed to the loss of order of the molecules. Second, the same model was considered, but with a noisy memoryless sequencing channel, which is assumed to be a binary symmetric channel (BSC) with crossover probability w (hence, over input-output alphabets of size 2), and for which the rate $(1 - \mathbb{P}[\text{erasure}])(1 - h_b(w) - 1/\beta)$ is achievable,¹ and is known to be the capacity only in the regime $w < 1/4$ and $\beta > \frac{2}{\log 2 - h_b(2w)}$ (in which a converse holds too). In [25], [27], the same BSC sequencing channel was assumed, yet with a different molecule sampling model. In [25], [27], it is assumed that the M molecules are sampled exactly N times, uniformly with replacement. In accordance, the samples distribution of the molecules is multinomial, and the number of times each molecule is sampled depends on other molecules. When $N = \alpha M$ and the *coverage depth parameter* α is a constant and M is asymptotically large, the empirical count of the number of times each molecule is sampled is known

¹We mainly use standard notation in the introduction. See Sec. II-A for notation conventions. Here $h_b(w)$ is the binary entropy function.

to tend to a Poisson distribution (an effect called *Poissonization*). Furthermore, if a molecule is sampled and sequenced d times, then it effectively undergoes a channel whose output is a set of d independent observations of its input. The capacity of this *binomial (multi-draw) BSC*, say $C_{w,d}$, has a simple closed-form expression [32]. In accordance, an upper bound on the capacity (converse) of this DNA storage channel model, which is valid for the regime $w < 1/8$ and $\beta > \frac{2}{\log 2 - h_b(4w)}$ was obtained in [25] as

$$C \geq \sum_{d \in \mathbb{N}} \pi_\alpha(d) \cdot C_{w,d} - \frac{1}{\beta}(1 - \pi_\alpha(0)) \quad (1)$$

where $\pi_\alpha(d)$ is the Poisson probability mass function (p.m.f.) with parameter α . The same expression was found to be a lower bound on the capacity (achievable), in the same regime for (w, β) .

For general DMCs beyond the BSC, it was described in [40, Sec. V.A, Thm. 3], that the capacity of the noiseless sequencing model can be generalized to any symmetric DMC, yet only when β is large enough, without specifying how large β should be. There are no claims in [40] on the noisy case, and the difficulty of extending the arguments to that case is explained to stem from the difficulty of bounding entropies under *general* capacity-achieving input distributions. In [25], [27] it is mentioned in passing that the results can be generalized to symmetric channels.

B. Contributions

In this paper, we follow the sampling model of [25], [27] of multinomial sampling with fixed coverage depth α , and improve on the results of [25], [27], [40] from several aspects:

- Our results apply to any DMC sequencing channel, including *asymmetric* ones.
- Our results improve on the best known capacity bounds even for symmetric channels,² and specifically, significantly improve the bounds for BSCs.
- We provide a single-letter lower bound on the reliability function of the system, which is based on a universal decoding rule.

Lower bounds (achievability): We derive a single-letter capacity lower bound, which naturally generalizes (1) to general DMCs, and prove that it is a lower bound on the capacity of the DNA storage channel, *without any restrictions* on β or the quality of the sequencing channel (Theorem 5). En route to the capacity lower bound, we analyze the error probability of a random code, and propose a suitable decoder. This decoder is *universal* – that is, does not require knowledge of the DMC sequencing channel – and it can be thought of as a penalized version of the *maximum mutual information* (MMI) decoder [12], [18]. The analysis of its error probability reveals that the dominating error event is not an atypical error event in the sequencing procedure, but rather an atypical sampling event. The sampling empirical distribution, to wit, the relative fraction of molecules which have been sampled d

²Symmetric in the sense of [8, Ch. 7.2].

times, for $d \in \{0, 1, \dots, N\}$, can be considered as a random *state* of the DNA storage channel. When sampling is “good”, the instantaneous capacity supported by the channel exceeds the target communication rate, and as we show, the conditional error probability decays exponentially fast as $e^{-\Theta(M \log M)}$. However, the probability that the sampling state is “bad” and the instantaneous capacity of the channel does not support the rate, decays slower, as $e^{-\Theta(M)}$, and thus dominates the error probability. The latter event is similar to an *outage* event in wireless communication systems [44], in which various phenomena such as multipath fading and interference cause the instantaneous capacity to drop below the required rate, and hence to a high error probability, while errors due to the additive Gaussian noise are less frequent. To quantify this effect, we prove a single-letter upper bound on the exponential decay of the outage probability (Theorem 8). Our proof methods are significantly different from the one in [40], which relied on explicit molecule indexing, as well as the one in [26], which is based on clustering the N outputs to (less than M) clusters, each pertaining to a different codeword.

Upper bounds (converse): We derive a single-letter expression similar to that of the lower bound, and prove it to be an upper bound, but with an additional excess-rate term (Theorem 10). The bound is valid for any $\beta > 1$ and there exists a critical value of β , such that the excess-rate term vanishes for all β larger than the critical. In that case, the upper bound on the capacity matches the lower bound. To prove this result, we follow the principal idea of [40] which was later elaborated in [25]. The core of the argument is that if the codebook is such that the M molecules comprising each codeword are very similar (or even identical), then their order is immaterial, and the loss term in rate associated with the ordering information, namely $\frac{1}{\beta}(1 - \pi_\alpha(0))$ in (1), is eliminated. On the other hand, when the order is preserved, codewords which maximize mutual information should have independent molecules, not identical. Thus, optimal codebooks should balance between these two conflicting requirements. The converse argument of [25], [40] shows that under the specified conditions on β and w (the crossover probability of the BSC sequencing channel), asymptotically optimal codewords should have independent molecules. In [25], [40], the similar-vs.-independent-molecules trade-off is concretely quantified by the Hamming distance. There, molecules are essentially “similar” if the Hamming distance between them is less than $4wL$, and otherwise “far” (and thus effectively independent). Thus the distinction between far and similar molecules is according to a radius which scales linearly in the molecule length L . By contrast, our proof utilizes a more general distance function, originating from exponential probabilities of typical sets [11, Ch. 2]. More importantly, the radius which distinguishes between similar and far is *sub-linear* in the molecule length L . This enables the aforementioned improvement of the upper (converse) bound.

It should also be mentioned that input alphabet size and the possible asymmetry of the sequencing channel greatly complicates the proof. In the analysis of BSC sequencing channels, the external property of the i.i.d. uniform $(\frac{1}{2}, \frac{1}{2})$ distribution (both separately for each molecules, and over all molecules) is typically easily justified. This is not the case for general DMCs. For example, while the binomial (multi-draw) extension of the BSC is symmetric for any d , this is not true for general symmetric channels (see Remark 7 and Appendix

C-A for details). Moreover, in the standard Fano-based proof of the converse to capacity of DMCs [8, Lemma 7.9.2], the output entropy for blocklength $K > 1$ is easily upper bounded by the sum of marginal entropies, and then the sum of K single-letter mutual information of each of them is upper bounded by the one obtained by the capacity achieving input distribution. For the DNA storage channel, it is not even clear a priori that the M molecules should be *identically* distributed (even if it is assumed that they are independent, or if it is somehow proved that no optimality is lost by independence). In our Fano-based converse argument, this requires to analyze mutual information for length L vectors, rather than their scalar counterpart in standard channel coding. See [40, Sec. V.A] for a related discussion.

Tightness of capacity bounds for modulo-additive noise channels: We evaluate our upper and lower bounds on the capacity for modulo-additive noise channels, which generalize the BSC channel for alphabets larger than 2. We provide an explicit sufficient condition on the minimal β required for the lower and upper bound to match. When specified for the BSC channel, the result displays a significant gain compared to [25], [27]. For example, for BSC(w) with $w = 0.05$, the minimal β required in [25], [27] is twice as large compared to our condition (see Fig. 2).

Significance: To begin with, the importance of general DMCs follows from the trivial fact that the physical DNA storage channel has four-letter input alphabet $\{A, C, G, T\}$, and at least 4 letters in the output alphabet. As we show (Prop. 6), symmetry of the sequencing channel leads to a suitable symmetry in the DNA storage channel if the output alphabet has size less or equal to 4. This is, however, not true for larger output alphabets (see a counterexample in Appendix C-A). Furthermore, the DNA storage channel is also known to be asymmetric in its nature – e.g., [15] states that “ $\{A, T\}$ are very likely to be mutually confused during sequencing, while the bases $\{G, C\}$ are much less likely to be misinterpreted for each other.”. As said, our bounds pertain to any DMC, which can be asymmetric.

Next, the importance of improved capacity bounds cannot be overstated, since the restrictions under which the capacity bounds hold can be described as *low-error* synthesis/sequencing. As discussed in [40], it is envisioned that next-generation DNA storage systems will deploy *high-error* synthesis/sequencing [1] in order to reduce costs. Thus, it is of interest to remove, or at least ameliorate, the conditions under which capacity is known (e.g., $\beta > 2/(\log 2 - h_b(4w))$ in the BSC case). As we next describe, our results remove completely such conditions for the lower (achievable) bound on capacity, and significantly improve the qualifying condition for the converse (upper) bound.

Finally, the fact that the sampling mechanism is the dominant error event, compared to sequencing errors should guide future designs of coded DNA storage systems.

C. Other Related Work

It was recognized long ago [34] that DNA molecules can serve as a medium to data storage, akin to their role in living organisms as carriers of genetic instructions. As surveyed in [20], prototypes of this concept have recently been developed by various groups of researches, starting with [7], [17], and followed by [19] which have deployed error-correcting codes [45], which have demonstrated selective file access, and [35] which have practically demonstrated the ability to store over 200 megabytes of data. Since DNA storage systems exhibit extreme high density, long durability [4], and low energy consumption [7], they are competitive candidates for future storage systems.

Several other papers have studied variations of the DNA storage channel model [14], [39], and various papers have proposed and analyzed coding schemes [7], [14], [17], [19], [21], [23], [35], [38], [41], [43], [45]. We refer the reader to [40, Sec. I.B] for a short description. In parallel to the study of fundamental limits of probabilistic channel models, combinatorial channel models were also studied. In [22], a channel model was considered in which, as for the DNA storage channel, codewords are multisets of unordered symbols, and upper bounds on the cardinality of optimal codes correcting any given number of errors were derived. This model differs from the model studied here as it assumes that the unordered symbols are taken from a constant size alphabet (compared to $L = \beta \log M$ scaling studied here), and does not take into account duplication. In [41] the redundancy required to be added in order to guarantee full protection against substitution errors was upper bounded. In [42] a sequence-subset distance has been proposed as a generalization of the Hamming distance suitable for the analysis of DNA storage channels, and generalizations of Plotkin and Singleton upper bounds on the maximal size of the codes were derived. In [24], Gilbert-Varshamov lower bounds and sphere packing upper bounds on the achievable cardinality of DNA storage codes were derived. These bounds complement the Shannon-theoretic analysis studied in [25], [26], [40] and in this paper.

D. Outline

The rest of the paper is organized as follows. In Sec. II we establish notation conventions and formulate the problem. In Sec. III we present our lower bounds (achievability results) on the capacity and reliability function, and in Sec. IV our upper bound on the capacity (converse results). In Sec. V we specify our capacity bounds to the case of modulo-additive sequencing channels (which the BSC is a specific case), and in Sec. VI we demonstrate our results via a numerical example. In Sec. VII we summarize the paper and discuss open problems.

II. PROBLEM FORMULATION

A. Notation Conventions

Random variables and vectors: Random variables will be denoted by capital letters, specific values they may take will be denoted by the corresponding lower case letters, and their alphabets will be denoted by calligraphic letters. Random vectors and their realizations will be super-scripted by their dimension. For example, the random vector $A^K = (A_0, \dots, A_{K-1}) \in \mathcal{A}^K$ (where $K \in \mathbb{N}^+$), may take a specific vector value $a^K = (a_0, \dots, a_{K-1}) \in \mathcal{A}^K$, the K th order Cartesian power of \mathcal{A} , which is the alphabet of each component of this vector. The Cartesian product of \mathcal{A} and \mathcal{B} (both finite alphabets) will be denoted by $\mathcal{A} \times \mathcal{B}$. The concatenation of two vectors, possibly of different lengths, will be denote by their juxtaposition, and the superscript of the resulting vector will be one of two forms – either by its total dimension, or by the number of vectors comprising it. An asterisk will be used in case each of these constituent vectors has a different length. For example, if $a_0^{K_0} \in \mathcal{A}^{K_0}$ and $a_1^{K_1} \in \mathcal{A}^{K_1}$ then their concatenation will be denoted as either $a^{K_0+K_1}$ or a^{*2} . The probability of the event \mathcal{E} will be denoted by $\mathbb{P}(\mathcal{E})$, and its indicator function will be denoted by $\mathbb{1}(\mathcal{E})$. The expectation operator with respect to (w.r.t.) a given distribution P will be denoted by $\mathbb{E}_P[\cdot]$ where the subscript P will be omitted if the underlying probability distribution is clear from the context. The empirical count operator $\mathcal{P}: \mathcal{A}^K \rightarrow [K+1]^{|A|}$ will be defined as the operator which converts a vector $a^K \in \mathcal{A}^K$ to its empirical count vector $n^{|A|} = \mathcal{N}(a^K)$ so that for any $a \in \mathcal{A}$

$$n_a = \sum_{k \in [K]} \mathbb{1}\{A_k = a\} \quad (2)$$

where $[K] := \{0, 1, \dots, K-1\}$. The empirical distribution operator $\mathcal{P}: \mathcal{A}^K \rightarrow \frac{1}{K}[K+1]^{|A|}$ will be defined via $\mathcal{N} = \frac{1}{K} \cdot \mathcal{P}$ so that $p^{|A|} = \mathcal{P}(a^K)$ is such that

$$p_a = \frac{1}{K} \sum_{k \in [K]} \mathbb{1}\{A_k = a\} = \frac{1}{K} \cdot n_a. \quad (3)$$

The composition of two operators \mathcal{P}_1 and \mathcal{P}_2 will be denoted by $\mathcal{P}_1 \circ \mathcal{P}_2$, and the K th functional power of \mathcal{P} will be defined via the recursion $\mathcal{P}^{(k)} := \mathcal{P} \circ \mathcal{P}^{(k-1)}$ with $\mathcal{P}^{(1)} := \mathcal{P}$.

Probability distributions, types and typical sets: We will follow the standard notation conventions for probability distributions, e.g., $P_A(a)$ will denote the probability of the letter $a \in \mathcal{A}$ under the distribution P_A of the random variable A . The arguments will be omitted when we address the entire distribution, e.g., P_A . Similarly, joint and conditional distributions of (A, B) will be denoted by P_{AB} and $P_{B|A}$ (respectively). The product distribution of P_A and $P_{B|A}$ will be denoted by $P_A \times P_{B|A}$. The support of a distribution P_A will be denoted by $\text{supp}(P_A)$. The set of possible distributions supported on \mathcal{A} (probability simplex) will be denoted by $\mathcal{P}(\mathcal{A})$. The set of conditional distributions on \mathcal{B} conditioned on an element of \mathcal{A} will be denoted by $\mathcal{P}(\mathcal{B} | \mathcal{A})$. In what follows, we will extensively utilize the *method of types* [10], [11] and the following notations. The *type class* of P_A at blocklength K , i.e., the set of all $a^K \in \mathcal{A}^K$ for which $\mathcal{P}(a^K) = P_A$ will be denoted by $\mathcal{T}_K(P_A)$.

The set of all type classes of vectors of length K from \mathcal{A}^K will be denoted by $\mathcal{P}_K(\mathcal{A})$ which is a subset of $\mathcal{P}(\mathcal{A})$. The V -shell (conditional type class) of a^K under the DMC $V: \mathcal{A} \rightarrow \mathcal{B}$, i.e., the set of all $b^K \in \mathcal{B}^K$ for which $\{b^K \in \mathcal{B}^K: \mathcal{P}(a^K, b^K) = \mathcal{P}(a^K) \times V\}$ will be denoted by $\mathcal{T}_K(V | a^K)$. For a given $P_A \in \mathcal{P}_K(\mathcal{A})$, the set of V -shells such that $\mathcal{T}_K(V | a^K)$ is not empty when $a^K \in \mathcal{T}_K(P_A)$ will be denoted by $\mathcal{P}_K(\mathcal{B} | P_A)$. The notion of typical sets, in the form of [11], will be used in the proof of the converse. Definitions, notations and basic results will thus appear before its proof, in Appendix B-A.

Information measures and probability divergences: Logarithms and exponents will be understood to be taken to the natural base. The binary entropy function $h_b: [0, 1] \rightarrow [0, 1]$ will be denoted by $h_b(a) := -a \log a - (1-a) \log(1-a)$ and the binary Kullback–Leibler (KL) divergence $d_b: [0, 1] \times (0, 1) \rightarrow \mathbb{R}^+$ by $d_b(a||b) := a \log \frac{a}{b} + (1-a) \log \frac{(1-a)}{(1-b)}$. In general, information-theoretic quantities will be denoted by the standard notation [8], with subscript indicating the distribution of the relevant random variables, e.g. $H_P(A | B)$, $I_P(A; B)$ and $I_P(A; B | \bar{B})$. Alternatively, the entropy of a distribution $P_A \in \mathcal{P}(\mathcal{A})$ will be denoted by $H(P_A)$, and the mutual information for a DMC V with input distribution P_A will be denoted by $I(P_A, V)$. The KL divergence between $Q_A \in \mathcal{P}(\mathcal{A})$ and $P_A \in \mathcal{P}(\mathcal{A})$ will be denoted by $D(Q_A || P_A)$, and the conditional KL divergence between $Q_{B|A} \in \mathcal{P}(\mathcal{B} | \mathcal{A})$ and $P_{B|A} \in \mathcal{P}(\mathcal{B} | \mathcal{A})$ averaged over $Q_A \in \mathcal{P}(\mathcal{A})$ will be denoted by $D(Q_{B|A} || P_{B|A} | Q_A)$. The total variation distance (\mathcal{L}_1 norm) of $P_1, P_2 \in \mathcal{P}(\mathcal{A})$ will be denoted by $|P_1 - P_2| := \sum_{a \in \mathcal{A}} |P_1(a) - P_2(a)|$.

General: The complement of a multiset \mathcal{A} will be denoted by \mathcal{A}^c . The number of *distinct* elements of a finite multiset \mathcal{A} will be denoted by $|\mathcal{A}|$. The equivalence relation will be denoted by \equiv , and will mainly be used to simplify notation at some parts of the paper (typically, the removal of subscripts/superscripts in order to avoid cumbersome notation). Asymptotic Bachmann–Landau notation will be used. Specifically, for a pair of positive sequences $\{f_K\}_{K \in \mathbb{N}}, \{g_K\}_{K \in \mathbb{N}}$ $f_K = O(g_K) \Leftrightarrow \limsup_{K \rightarrow \infty} \frac{f_K}{g_K} < \infty$, and $f_K = \Theta(g_K) \Leftrightarrow \{f_K = O(g_K) \text{ and } g_K = O(f_K)\}$, $f_K = o(g_K) \Leftrightarrow \lim_{K \rightarrow \infty} \frac{|f_K|}{g_K} = 0$, and $f_K = \omega(g_K) \Leftrightarrow \lim_{K \rightarrow \infty} \frac{|f_K|}{g_K} = \infty$. A variable appearing in the subscript of an asymptotic order term, e.g., α in $f_K = O_\alpha(K)$, emphasizes that the constants involved in the asymptotic relation depend on that variable (possibly, in addition to other variables). Minimum and maximum will be denoted as $\min(a, b) := a \wedge b$, $\max(a, b) := a \vee b$, as well as $[a]_+ = a \vee 0$. Throughout, for the sake of brevity, integer constraints on large numbers which are inconsequential will be ignored, for example, the number of codewords in a rate R codebook of dimension K will be simply written as e^{KR} (instead of $\lceil e^{KR} \rceil$). The Hamming distance between $a^K, \bar{a}^K \in \mathcal{A}^K$ will be denoted by $\rho_H(a^K, \bar{a}^K) := \sum_{k \in [K]} \mathbb{1}\{a_k \neq \bar{a}_k\}$.

B. Formulation of the DNA Storage Channel

In this section, we formulate the DNA storage channel model, or DNA channel, in short. This channel will be indexed by the number of molecules M in a codeword, which, in what follows, will be used to gauge the dimension of the codewords.

The encoder: A DNA molecule is a sequence of $L \equiv L_M \in \mathbb{N}^+$ nucleotides (symbols) chosen from an alphabet \mathcal{X} , where in physical DNA storage systems, $\mathcal{X} = \{A, C, G, T\}$. Thus, each molecule is uniquely represented by a sequence $x^L \in \mathcal{X}^L$. A codeword is a sequence of M molecules, $x^{LM} = (x_0^L, \dots, x_{M-1}^L)$, where $x_m^L \in \mathcal{X}^L$ for all $m \in [M]$.³ Thus a codeword has total ML nucleotides (or symbols) from \mathcal{X} . A codebook is a set of different codewords, $\mathcal{C} = \{x^{LM}(j)\}$.

The channel model (reading mechanism): At the time of reading, the codeword $x^{LM}(j)$ undergoes two stages which can be considered as a channel operation that produces the output for the decision on the stored message. The DNA channel is parameterized by the number of molecule samples $N \equiv N_M \in \mathbb{N}^+$, and a sequencing channel $W: \mathcal{X} \rightarrow \mathcal{Y}$. The channel operates on $x^{LM}(j)$ as follows:

1) Sampling: N molecules are sampled uniformly from the M molecules of $x^{LM}(j)$, independently, with replacement. Let $U^N \in [M]^N$ be such that U_n is the sampled molecule at sampling event $n \in [N]$. We refer to U^N as the *molecule index vector*, and it holds that $U^N \sim \text{Uniform}([M]^N)$. The result of the sampling stage is thus the vector

$$(x_{U_0}^L(j), x_{U_1}^L(j), \dots, x_{U_{N-1}}^L(j)) \in (\mathcal{X}^L)^N. \quad (4)$$

In what follows, we will use the following additional definitions. Let $S^M \in [N]^M$ be such that S_m is the number of times that molecule m was sampled, to wit $S_m = \sum_{n \in [N]} \mathbb{1}\{U_n = m\}$, the empirical count of U^N . It holds that $S^M \sim \text{Multinomial}(N; (\frac{1}{M}, \frac{1}{M}, \dots, \frac{1}{M}))$, and we refer to S^M as the *molecule duplicate vector*. In a similar fashion, let $Q^{N+1} \in [M+1]^{N+1}$ be such that Q_d is the number of molecules that have been sampled d times, to wit $Q_d = \sum_{m \in [M]} \mathbb{1}\{S_m = d\}$, the empirical count of S^M . We refer to Q^{N+1} as the *amplification vector*. Note that $\sum_{d \in [N+1]} Q_d = M$ and that $\sum_{d \in [N]} dQ_d = N$ hold with probability 1. Note that using the definition of the empirical count operator in (2), it holds that $S^M = \mathcal{N}(U^N)$ and $Q^{N+1} = \mathcal{N}(S^M) = \mathcal{N}^{(2)}(U^N)$. See Fig. 1 for an illustration.

2) Sequencing: For each $n \in [N]$, $x_{U_n}^L(j)$ is sequenced to $Y_n^L \in \mathcal{Y}^L$, and the sequencing of $x_{U_n}^L(j)$ is independent for all $n \in [N]$. Denoting the channel output by $Y^{LN} = (Y_0^L, \dots, Y_{N-1}^L) \in (\mathcal{Y}^L)^N$ it thus holds that

$$\mathbb{P}[Y^{LN} = y^{LN} \mid x^{LM}(j), U^N] = \prod_{n \in [N]} W^L(y_n^L \mid x_{U_n}^L(j)), \quad (5)$$

where W^L is the L th product of the DMC W , that is, $W^L(y^L \mid x^L) = \prod_{i \in [L]} W(y_i \mid x_i)$.

³In principle, the codeword is actually a *multiset* of M molecules, that is, the order is not specified. However, for analysis, it is convenient to assume an arbitrary ordering of the molecules. As evident from the description of the amplification step, this order does not affect the channel output. In addition, we use the notation $x^{LM} \equiv (x^L)^M$ rather than the equivalent x^{ML} as a mnemonic to the fact that the codeword is a sequence of M length- L molecules (which the channel permutes).

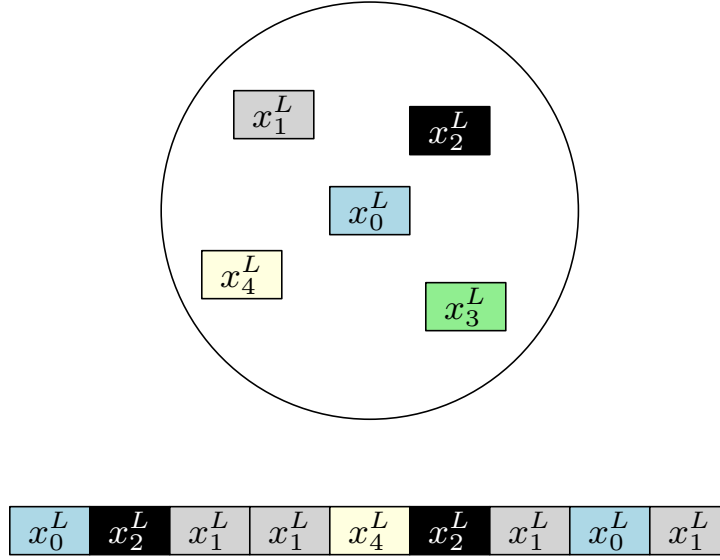

Figure 1. Illustration of a sampling event for $M = 5$, and $N = 9$. Here, $U^9 = (0, 2, 1, 1, 4, 2, 1, 0, 1)$, $S^5 = (2, 4, 2, 0, 1)$ and $Q^{10} = (1, 1, 2, 0, 1, 0, 0, 0, 0, 0)$.

Due to the random sampling stage, it is clear that the order of Y_n^L in Y^{LN} is immaterial. Indeed, the likelihood of y^{LN} conditioned on an input x^{LM} is given by

$$\mathcal{L}[y^{LN} | x^{LM}] := \sum_{u^N \in [M]^N} \mathbb{P}[U^N = u^N] \prod_{n \in [N]} W^L[y_n^L | x_{u_n}^L]. \quad (6)$$

$$= \frac{1}{M^N} \sum_{u^N \in [M]^N} \prod_{n \in [N]} W^L[y_n^L | x_{u_n}^L]. \quad (7)$$

The decoder: The decoder $(\mathcal{Y}^L)^N \rightarrow [|\mathcal{C}|]$ maps the channel output to a codeword index, and with a slight abuse of notation, we identify the decoder with the set of the decision regions $\mathcal{D} = \{\mathcal{D}(j)\}_{j \in [|\mathcal{C}|]}$, where $\mathcal{D}(j)$ is the decision region of the j th codeword $\mathcal{D}(j) := \{y^{LN} : \mathcal{D}(y) = j\}$.

Global assumptions: We will assume throughout that:

- 1) Molecule length scaling: $L \equiv L_M = \beta \log M$ where $\beta > 1$ is the molecule length parameter.
- 2) Coverage depth: $N = \alpha M$ where $\alpha > 0$ is the coverage depth parameter.

The DNA channel is thus indexed by M and parameterized by $\text{DNA} := (\alpha, \beta, W)$. The (storage) rate of the codebook \mathcal{C} is given by

$$R = \frac{\log |\mathcal{C}|}{ML} \quad (8)$$

and by the assumption $|\mathcal{C}| = e^{RML} = e^{R\beta M \log M}$. Note that compared to the scaling $|\mathcal{C}| = e^{MR}$ in standard channel coding problems, there is an extra $L = \beta \log M$ factor in the effective codeword length. The error probability of \mathcal{D} given that $x^{LM}(j) \in \mathcal{C}$ was stored is given by

$$\text{pe}(\mathcal{C}, \mathcal{D} | x^{LM}(j)) := \sum_{y^{LN} \in \mathcal{D}^c(j)} \mathcal{L}[y^{LN} | x^{LM}(j)]. \quad (9)$$

Let a DNA channel $\text{DNA} := (\alpha, \beta, W)$ be given.

Definition 1 ((M, ϵ) -code). \mathcal{C} is an (M, ϵ) -code for the DNA channel DNA of dimension M and $\epsilon \in [0, 1)$ if there exists a decoder \mathcal{D} such that $\max_{j \in [|\mathcal{C}|]} \text{pe}(\mathcal{C}, \mathcal{D} \mid x^{LM}(j)) \leq \epsilon$.

In addition, we will denote the average error probability by $\text{pe}(\mathcal{C}, \mathcal{D}) := \frac{1}{|\mathcal{C}_M|} \sum_{j \in [|\mathcal{C}_M|]} \text{pe}(\mathcal{C}, \mathcal{D} \mid x^{LM}(j))$.

Definition 2 (Capacity). The rate $R \in \mathbb{R}^+$ is ϵ -achievable for the channel DNA and $\epsilon \in [0, 1)$ if for every $\delta > 0$ and every M sufficiently large there exists a codebook \mathcal{C}_M of size $|\mathcal{C}_M| \geq e^{ML(R-\delta)}$ such that \mathcal{C}_M is an (M, ϵ) -code. The rate R is achievable if it is an ϵ -achievable rate for all $\epsilon \in (0, 1)$. The supremum of achievable rates is the *capacity* $C \equiv C(\text{DNA})$ of the channel.

Definition 3 (Reliability function). Let $K_M: \mathbb{N}^+ \rightarrow \mathbb{N}^+$ be monotonic increasing. An *error exponent* $E(R)$ w.r.t. scaling K_M is achievable for channel DNA at rate $R < C$ if there exists a sequence $\{\mathcal{C}_M, \mathcal{D}_M\}_{M \in \mathbb{N}^+}$ so that⁴

$$\liminf_{M \rightarrow \infty} -\frac{1}{K_M} \log \left[\max_{j \in [|\mathcal{C}|]} \text{pe}(\mathcal{C}, \mathcal{D} \mid x^{LM}(j)) \right] \geq E(R). \quad (10)$$

The supremum of all error exponents $E(R)$ achieved w.r.t. scaling K_M is the reliability function $E^*(R) \equiv E^*(R, \text{DNA}, \{K_M\})$ of the channel DNA w.r.t. to scaling K_M .

III. LOWER BOUNDS

In order to state our results we will need a few notations and definitions. Let $\tilde{S} \sim \text{Pois}(\alpha)$ and $\pi_\alpha(d) := \frac{\alpha^d e^{-\alpha}}{d!}$ for $d \in \mathbb{N}$ be the Poisson p.m.f. so that $\mathbb{P}[\tilde{S} = d] = \pi_\alpha(d)$. Further, for any given $d \in \mathbb{N}^+$, let the *hazard probability* of \tilde{S} be

$$\pi_{\alpha| \geq d}(d') := \mathbb{P} \left[\tilde{S} = d' \mid \tilde{S} \geq d \right] = \frac{\pi_\alpha(d')}{1 - \sum_{i \in [d]} \pi_\alpha(i)} \quad (11)$$

for all $d \in \mathbb{N}^+$ and $d' \geq d$.

Definition 4 (The d -order binomial extension of a DMC). Let \mathcal{A}, \mathcal{B} be finite input and output alphabets (respectively), let $V: \mathcal{A} \rightarrow \mathcal{B}$ be a DMC, and let $d \in \mathbb{N}^+$. We call the DMC $V^{\oplus d}: \mathcal{A} \rightarrow \mathcal{B}^d$ the *d -order binomial extension* of V if $V^{\oplus d}[b^d \mid a] = \prod_{i=0}^{d-1} V(b_i \mid a)$ for all $a \in \mathcal{A}, b^d \in \mathcal{B}^d$.

Thus the output of the channel $V^{\oplus d}$ is a sequence of d conditionally independent observations of its input a . For brevity, we will refer to $V^{\oplus d}$ as a *d -order binomial channel*, whose capacity is $C(V^{\oplus d}) = \max_{P_A} I(P_A, V^{\oplus d})$. By the data processing theorem, it is clear that $I(P_A, V^{\oplus d})$, and hence $C(V^{\oplus d})$, are monotonic non-decreasing in d .

⁴We define here achievable error exponent with a stringent definition using limit inferior. The relation (equality/inequality) between the reliability function defined with limit inferior and the reliability function defined with limit superior is still unsettled even for standard DMCs [11, Problem 10.7]

A. A Lower Bound on the Capacity

We begin with a lower bound on the capacity:

Theorem 5. *The capacity of the DNA channel, $\text{DNA} := (\alpha, \beta, W)$, is lower bounded as*

$$C(\text{DNA}) \geq \max_{P_X \in \mathcal{P}(\mathcal{X})} \sum_{d \in \mathbb{N}^+} \pi_\alpha(d) \cdot I(P_X, W^{\oplus d}) - \frac{1}{\beta} (1 - \pi_\alpha(0)). \quad (12)$$

Theorem 5 is a consequence of Theorem 8 which appears next in Sec. III-B, and which provides a lower bound to the reliability function. Its short proof (as a corollary to Theorem 8) appears at the beginning of Appendix A. We next highlight a few features and implications of Theorem 5.

Interpretation of the capacity bound: Had the decoder known the molecule index vector U^N , it would have matched each of the M input molecules, X_m^L , to the S_m output molecules Y_{U_n} for which $U_n = m$. The molecule X_m^L and those outputs $\{Y_n^L\}_{n:U_n=m}$ can then be considered as an input-output pair of a (S_m) -order binomial extension of W . The mutual information for input distribution P_X of this channel is $L \cdot I(P_X, W^{\oplus d})$. Out of the M input molecules, there are Q_d molecules which were input to a d -order binomial channel. Their total mutual information is then $LQ_d \cdot I(P_X, W^{\oplus d})$, and summing over all possible $d \in [N+1]$, the total mutual information for ML channel uses is $\sum_{d \in [N+1]} LQ_d \cdot I(P_X, W^{\oplus d})$. Now, since U^N is a uniform random vector, its empirical count, $S^M = \mathcal{N}(U^N)$, is distributed as a multinomial, and so, $Q^{N+1} = \mathcal{N}(S^M)$ is the empirical count of a multinomial distribution. An effect known as *Poissonization* (see Fact 19 in Appendix A-E) implies that this distribution tends to a Poisson distribution. Thus $\frac{Q_d}{M} \approx \pi_\alpha(d)$, and the total mutual information for ML channel uses is then $ML \sum_{d \in [N+1]} \pi_\alpha(d) Q_d \cdot I(P_X, W^{\oplus d})$. This leads to the first term in the capacity lower bound. The second term, $\frac{1}{\beta}(1 - \pi_\alpha(0))$, reduces the bound, and reflects the fact that the decoder does not know U^N , and thus needs to order all non-erased molecules, either implicitly or explicitly. For example, an indexing-based scheme [40], can use $\log M$ nats out of the $\beta \log M$ of each of the M molecules to specify its index, and diminishes the effective rate by exactly $\frac{1}{\beta}(1 - \pi_\alpha(0))$. By contrast, our scheme is designed to achieve a non-trivial lower bound on the reliability function, without relying on sending an explicit indexing information. Nonetheless, it still suffers the rate loss $\frac{1}{\beta}(1 - \pi_\alpha(0))$, which in light of the upper bound (converse) is indeed inevitable in some regime.

Comparison to previous results: In [40], the sampling model is such that S_m are i.i.d., and that $S_m \in \{0, 1\}$ where $\mathbb{P}[S_m = 0]$ is an erasure probability. That is, any of the M molecules is either sampled once or none at all. For a BSC(w) sequencing channel (cf. Sec. V) the rate achieved in [40, Sec. IV.A] is

$$R = (1 - \mathbb{P}[S_m = 0]) \cdot [1 - h_b(w) - 1/\beta]. \quad (13)$$

Per the interpretation of the capacity bound above, $\pi_\alpha(d)$ represents the fraction of molecules which have been sampled d times. Thus (13) agrees with Theorem 5 by replacing $\pi_\alpha(d) \rightarrow \mathbb{P}[S_m = d]$ for $d \in \{0, 1\}$ and

$\pi_\alpha(d) \rightarrow 0$ for $d > 1$, as well as choosing $P_X = (\frac{1}{2}, \frac{1}{2})$ (cf. Theorem 9).

In [27], it was shown, for the sampling model S^M , which we adopt here, and for a BSC(w) sequencing channel, that the rate

$$\sum_{d \in \mathbb{N}^+} \pi_\alpha(d) \cdot I\left(\left(\frac{1}{2}, \frac{1}{2}\right), \text{BSC}(w)^{\oplus d}\right) - \frac{1}{\beta}(1 - \pi_\alpha(0)) \quad (14)$$

is achievable, but only in the regime $w \leq \frac{1}{8}$ and $\beta > \frac{2}{\log 2 - h_b(4w)}$. Here the rate implied by (12) is the same, and holds for any $w \in [0, \frac{1}{2}]$ and $\beta > 1$. See Sec. V for a more detailed comparison.

Choice of input distribution: The lower bound on capacity in (12) is a weighted sum of mutual information terms $\{I(P_X, W^{\oplus d})\}_{d \in \mathbb{N}^+}$ according to the Poisson distribution. In general, the input distribution $P_{X,d}$ which maximizes $I(P_X, W^{\oplus d})$ is different for each d , and in that case the input distribution which maximizes the objective in (12) would be a compromise between those input distributions $\{P_{X,d}\}_{d \in \mathbb{N}^+}$. Interestingly, this may occur even for some *symmetric* sequencing channels (see Remark 7 in what follows). Nonetheless, for some particularly relevant symmetric sequencing channels W , the maximizing input distribution is *provably* uniform (see Definition 36 for a symmetric channel in Appendix C-A).

Proposition 6. *If $|\mathcal{X}| \leq 4$, $|\mathcal{Y}| \leq |\mathcal{X}|$, and W is a symmetric channel in Gallager's sense [16, p. 94] without any identical rows, then the lower bound on the capacity (12) is achieved by the uniform input distribution, $P_X^{(unif)} = (\frac{1}{|\mathcal{X}|}, \dots, \frac{1}{|\mathcal{X}|})$. The same holds if W is a modulo-additive channel for any $\mathcal{X} = \mathcal{Y}$.*

Proof: The claim follows since the mutual information $I(P_X, W)$ for a symmetric channel W in Gallager's sense (see Definition 36 in Appendix C-A) is maximized by the uniform input distribution [16, Thm. 4.5.2]. As we show in Prop. 37 and Prop. 38 in Appendix C-A, the binomial extension of any order d of the channels which satisfy the conditions of the proposition is symmetric in Gallager's sense. Thus, the uniform input distribution simultaneously maximizes all terms in the sum (12). ■

Remark 7. The qualifying conditions in Prop. 6 cannot be refined. There is no general guarantee that if W is symmetric then $W^{\oplus d}$ is symmetric in Gallager's sense for $d > 1$. There is a symmetric channel with $|\mathcal{X}| = |\mathcal{Y}| = 5$ that does not satisfy that. Moreover, if a channel W is only symmetric in Gallager's sense, there is no such guarantee even if $|\mathcal{X}| = 4$. There is a symmetric channel in Gallager's sense with $|\mathcal{X}| = 4, |\mathcal{Y}| = 8$ that does not satisfy that. See the end of section C-A for the specific channel matrices. Hence, the input distribution which maximizes the lower bound (12) will *not be uniform*.

B. A Lower Bound on the Reliability Function

Theorem 5 is a direct implication of the following stronger result which is a lower bound on the reliability function. In short, the next theorem shows that the error probability decays to zero exponentially fast w.r.t. to the scaling $K_M = M$ for all rates below the lower bound on the capacity in Theorem 5.

Theorem 8. *The reliability function of the DNA channel $\text{DNA} := (\alpha, \beta, W)$ w.r.t. scaling $K_M = M$ is lower bounded as*

$$E^*(R, \text{DNA}, \{M\}) \geq \max_{P_X \in \mathcal{P}(\mathcal{X})} \inf_{\{\theta_d\}_{d \in \mathbb{N}}} \sum_{d \in \mathbb{N}} \left(1 - \sum_{i \in [d]} \theta_i \right) \cdot d_b \left(\frac{\theta_d}{1 - \sum_{i \in [d]} \theta_i} \middle| \middle| \pi_{\alpha|\geq d}(d) \right) \quad (15)$$

where the minimization is subject to:

$$\left\{ \theta_d \in (0, 1] \quad \forall d \in \mathbb{N}, \sum_{d \in \mathbb{N}} \theta_d = 1, \sum_{d \in \mathbb{N}} \theta_d \cdot I(P_X, W^{\oplus d}) - \frac{1}{\beta}(1 - \theta_0) < R \right\}. \quad (16)$$

We next highlight a few features and implications of Theorem 8:

Choice of decoder: The error exponent in (15) is achieved for a universal decoder which is oblivious to the channel W .⁵ This universal decoder is a variant of the MMI decoding rule, which given a channel output, y^{LM} , computes a metric for each of the codewords, $x^{LM}(j)$, as follows. Recall that the molecule index vector, u^N , designates a possible sampling event, in which molecule u_n was sampled at the n th sampling trial. Considering a candidate u^N , the decoder partitions the ML molecule symbols into groups according to the number of times that molecule has been sampled. A symbol which belongs to the d th group thus has d independent output symbols, which can be considered a single super-symbol from \mathcal{Y}^d . The decoder computes the empirical mutual information for each group, and then the total empirical mutual information, is weighted according to the groups size. The decoder repeats this computation for all possible candidate u^N vectors,⁶ and then chooses a *penalized* maximum of the weighted empirical mutual information over all u^N candidates. The penalty term is related to the amplification vector q^{N+1} for which $q^{N+1} = \mathcal{N}^{(2)}(u^N)$ holds. Specifically, the penalty reduces the metric of those u^n for which there is a large number of other candidates \tilde{u}^N for which $\mathcal{N}^{(2)}(\tilde{u}^N) = \mathcal{N}^{(2)}(u^N) = q^{N+1}$ also holds. We term this set the *amplification type class* of q^{N+1} .

Proof outline and main ideas: Appendix A is devoted to the proof of the lower bounds (achievability results). It begins with two preliminary sections. First, in Appendix A-A, a tight characterization of the asymptotic size of the amplification type class is provided, which is required for the penalty term of the universal decoder. Second, in Appendix A-B, the likelihood of the DNA channel is cast as the likelihood of a repeated mixture – the mixture over molecule index vectors u^N , and the mixture of binomial channels of different orders.

We prove Theorems 5 and 9 by analyzing the error probability of the universal decoder. In Appendix A-C, we utilize the u^N molecule-index/binomial mixture interpretation of the DNA channel to rigorously define this universal decoder. In Appendix A-D, we condition on specific amplification vector $Q^{N+1} = q^N$, and analyze the average error probability of a codebook randomly chosen from the standard i.i.d. input ensemble and the universal decoder. We then prove Theorem 8 by averaging the error probability w.r.t. Q^{N+1} for the sampling mechanism of the DNA channel. Here the *Poissonization effect* (Fact 19), which implies that $\frac{Q_d}{M} \approx \pi_\alpha(d)$ is

⁵We nonetheless mention, that, as usual, an optimal choice of the input distribution, P_X , depends on the channel W .

⁶Strictly speaking, for a judiciously chosen subset of all possible u^N .

used. However, unlike its usage for capacity analysis in [26], here we consider its effect on the error probability, and accordingly, its effect on tail probabilities.

Comparison to previous proof techniques: As said, there are no claims in [27], [40] regarding the decay rate of the error probability. However, it is still enlightening to compare their coding schemes to ours, as they are considerably different.

The coding scheme of [40] is based on molecule indexing and on concatenation of inner and outer codes. Recall that in [40], $S_m \in \{0, 1\}$ with probability 1. The outer code is designed to correct erased (non-sampled) molecules, while the inner code is designed to correct the errors of the sequencing channel ($\text{BSC}(w)$, in case of [40]), as well as to identify the index of the molecule, and thus allow the decoder to order the output molecules. Specifically, the outer code operates on super-symbols of blocklength M , and has rate $1 - \mathbb{P}[S_m = 0]$. Thus, it can correct up to $M \cdot \mathbb{P}[S_m = 0]$ erased molecules. Each super-symbol encodes roughly $L(1 - h_b(w) - 1/\beta)$ bits. Each the M molecules of the output alphabet of the outer code, is appended with $\log_2 M$ bits which identifies the index m of the molecule. The resulting $L(1 - h_b(p))$ bits of each molecule are encoded to L bits using the inner code, designed to be capacity achieving for $\text{BSC}(w)$. At reading time, the inner code is first decoded, *individually* for each molecule. Assuming a correct inner-code decoding of all sampled molecules, they can be ordered using the header which identifies their index, and then the outer erasure-correcting code can correct the erased molecules. By contrast, in order to obtain a fast decaying error probability bound, our scheme neither uses concatenated codes nor explicit indexing. As a crude comparison with the error probability of the scheme of [40], we claim that an inner-code decoding error of a *single* molecule would lead to a message decoding error. Accordingly, this would lead to an error probability which is at most $e^{-\Theta(L)} = e^{-\Theta(\log M)}$, i.e., polynomial in M . This is much slower than the exponential decay w.r.t. scaling of $K_M = M$ achieved here.⁷

The coding scheme of [26] is based on the standard random coding i.i.d. ensemble, and a non-standard decoder, which is mainly tailored to the BSC case,⁸ and is very different from the decoder proposed here. The decoder employs a clustering algorithm in order to overcome the possible (and likely) multiple appearances of a single molecule at the output vector Y^{LN} , and lack of any prior ordering information that can match Y_n^L with the molecule generated it. This clustering algorithm is greedy, and with high probability, it clusters the N outputs to $M(1 - \pi_\alpha(0))$ clusters, such that an output cluster is the result of sequencing of one of the M molecules, and where $M\pi_\alpha(0)$ molecules are erased. The clustering algorithm is based on Hamming distances – thus it is mainly suitable to a BSC sequencing channel – and requires the channel crossover probability as input. Furthermore, for successful clustering, it is required that the minimum distance between the molecules of the true stored codeword (that is, the minimum distance among the M sequences of L bits representing the codeword) is at least $\approx 4wL$. This “hard” requirement is the source of the limited regime of (w, β) in the result

⁷In fact, the error probability in the model of [40] can decay at most exponentially w.r.t. scaling $K_M = M$ since S^M in the model therein is i.i.d. (binary) vector, and so there is a probability of $\mathbb{P}[S_m = 0]^M = e^{-\Theta(M)}$ that all M molecules are erased.

⁸Though it is mentioned in passing that the analysis is also suitable for symmetric channels.

(cf. [26, Lemma 4]). The decoded codeword is the unique one which is weakly jointly typical (in the sense of [8, Ch. 7]) with the output clusters obtained by the clustering algorithm. As is well known, jointly typical decoding suffices to achieve capacity, but it is otherwise too weak for obtaining tight error probability bounds. It seems to be fairly non-trivial to extend the arguments of [26, Lemma 4] to more powerful decoders.

Outage interpretation: According to Theorem 8, there exists a rate \underline{C} (which is a lower bound on the capacity), such that the error probability decays exponentially in M for all rates below \underline{C} . In the reliability function bound, the variable θ_d represents $\frac{q_d}{M}$ – the fraction of molecules (out of M) that were sampled d times during the sampling stage. Conditioned on an amplification vector q^{N+1} , or, equivalently, on θ , the term on the left-hand side of the constraint (16), to wit, $\sum_{d \in \mathbb{N}} \theta_d \cdot I(P_X, W^{\oplus d}) - \frac{1}{\beta}(1 - \theta_0)$ is thus the conditional “supported” rate $R(\{\theta_d\})$. If the random supported rate is above the coding rate R , then the error probability decays at exponential rate w.r.t. scaling ML (as we show in the proof of Theorem 8). Otherwise, if the supported rate is below the coding rate, we may trivially upper bound the error probability by 1. Thus, the error probability, averaged over Q^{N+1} , is upper bounded as

$$\text{pe}(\mathcal{C}, \mathcal{D}) \leq \mathbb{P}[R(\{\theta_d\}) < R] \cdot e^{-\Theta(ML)} + \mathbb{P}[R(\{\theta_d\}) < R] \cdot 1. \quad (17)$$

As shown in the proof of Theorem 8, the decay rate of $\mathbb{P}[R(\{\theta_d\}) < R]$ is exponential only in M , and thus dominates the error probability. This event can be thought of as an *outage* event, in which the random state of the channel (due to the sampling stage) does not allow for coding at the required rate with low error probability.

Sampling versus loss of order: The DNA channel affects the stored codeword in two non-standard ways: the lack of molecule order, and the random number of copies of the molecule present before the sequencing stage – which can cause either duplication or erasure of a molecule (beyond the error in sequencing, which are modeled here as a standard DMC). As Theorem 8 shows, the resulting error probability is dominated by outage, resulting from the randomness in the number of copies of the molecule, and is exponential in M . It turns out that when the sampling stage is ideal, and each molecule is sampled *exactly* α times, the error probability decays much faster, and it is of exponential in $ML = \beta M \log M$. Specifically, a slight modification of the proof of Theorem 8 yields the following:

Theorem 9. *Consider an idealized sampling DNA channel $\text{DNA}_{ideal} := (\alpha, \beta, W)$ in which $S_m = \alpha$ for all $m \in [M]$ with probability 1. Then,*

$$\begin{aligned} & E^*(R, \text{DNA}_{ideal}, \{ML\}) \\ & \geq \max_{P_X \in \mathcal{P}(\mathcal{X})} \min_{Q_{XY^\alpha} \in \mathcal{P}(\mathcal{X} \times \mathcal{Y}^\alpha)} D(Q_X \parallel P_X) + D(Q_{Y^\alpha|X} \parallel W^{\oplus \alpha} | Q_X) + \left[D(Q_A \parallel P_X) + I_Q(X; Y^\alpha) - \frac{1}{\beta} - R \right]_+. \end{aligned} \quad (18)$$

The proof of Theorem 9 is a simplified and slightly modified version of the proof of Theorem 8, and it

appears at the end of Appendix A.

IV. AN UPPER BOUND ON CAPACITY

We next turn to state our upper bound on the capacity. To this end, consider a DMC $V: \mathcal{X} \rightarrow \mathcal{Y}$ and $(X, Y, \bar{Y}) \in \mathcal{X} \times \mathcal{Y}^2$ and for which

$$\mathbb{P}[X = x, Y = y, \bar{Y} = \bar{y}] = P_X(x) \cdot V(y | x) \cdot V(\bar{y} | x). \quad (19)$$

That is, Y and \bar{Y} are two conditionally independent observations given a common input X to the DMC V . We then define the *common-input (mutual information) deficit (CID)* $\text{CID}: \mathcal{P}(\mathcal{X}) \times \mathcal{P}(\mathcal{Y} | \mathcal{X}) \rightarrow \mathbb{R}^+$ as

$$\text{CID}(P_X, V) := 2 \cdot I(X; Y) - I(X; Y, \bar{Y}) \quad (20)$$

$$= 2 \cdot I(P_X, V) - I(P_X, V^{\oplus 2}). \quad (21)$$

The CID measures the loss in mutual information when the same input is fed into a pair of independent channels, compared to the case of independent inputs. It also holds that $\text{CID}(P_X, V) = I(Y; \bar{Y})$ (see Prop. 25 in Appendix B-B3).

As in [25], [40], our upper bound on the capacity does not match the lower bound for all sequencing channels and molecule length parameter β . To present this gap in a concise manner, we define the *d-order excess-rate* term by

$$\begin{aligned} \Omega_d(\beta, P_X, W) &:= \begin{cases} \frac{1}{\beta}, & \text{CID}(P_X, W^{\oplus d}) < \frac{1}{\beta} \\ -\text{CID}(P_X, W^{\oplus d}) + \frac{2}{\beta}, & \frac{1}{\beta} \leq \text{CID}(P_X, W^{\oplus d}) < \frac{2}{\beta} \\ 0, & \text{CID}(P_X, W^{\oplus d}) \geq \frac{2}{\beta} \end{cases} \\ &= \left[\frac{1}{\beta} \wedge \left(\frac{2}{\beta} - \text{CID}(P_X, W^{\oplus d}) \right) \right]_+. \end{aligned} \quad (22)$$

Theorem 10. Assume that the DNA channel $\text{DNA} := (\alpha, \beta, W)$ satisfies

$$\nu_{\min}(W) := \max_{x \in \mathcal{X}, y \in \mathcal{Y}} \log \frac{1}{W(y | x)} < \infty. \quad (23)$$

Then, its capacity is upper bounded as

$$C(\text{DNA}) \leq \max_{P_X \in \mathcal{P}(\mathcal{X})} \sum_{d \in \mathbb{N}^+} \pi_\alpha(d) \cdot \left[I(P_X, W^{\oplus d}) + \Omega_d(\beta, P_X, W) \right] - \frac{1}{\beta} (1 - \pi_\alpha(0)). \quad (24)$$

The main ideas of the proof: The proof follows the main argument of [25], [40]. Thus, we first describe the argument and then emphasize where our proof argument deviates from previous analysis. From Fano's inequality, the rate of a reliable code is upper bounded by the mutual information $I(X^{LM}; Y^{LN})$, and so the main task is to upper bound the mutual information of the, rather non-standard, DNA channel. This upper bound should ideally

match the lower bound of Theorem 5, which is comprised of two terms, to wit, $\sum_{d \in \mathbb{N}^+} \pi_\alpha(d) \cdot I(P_X, W^{\oplus d})$ and $-\beta^{-1}(1 - \pi_\alpha(0))$. If the decoder was aware of U^N , say as side information, then standard arguments and Poissonization bound the mutual information as

$$I(X^{LM}; Y^{LN}, U^N) = \underbrace{I(X^{LM}; U^N)}_{=0} + I(X^{LM}; Y^{LN} | U^N) \leq \sum_{d \in \mathbb{N}^+} \pi_\alpha(d) \cdot I(P_X, W^{\oplus d}) \quad (25)$$

which is the first term of the lower bound. Therefore, the rate loss term, $-\beta^{-1}(1 - \pi_\alpha(0))$, is clearly related to the lack of knowledge of U^N by the decoder, or, loosely speaking, the loss of order of the molecules in the DNA channel. Moreover, as in the standard upper bound on the mutual information of a DMC, the bound (25) is achieved by choosing the M molecules $\{X_m^L\}_{m \in [M]}$ to be i.i.d. (in fact, their ML symbols are all i.i.d. too). If one uses such independent molecules for the DNA channel, in which U^N is unknown, then the decoder must discern between $(X_0^L, X_1^L, \dots, X_{M-1}^L)$ and any other permutation of them. Thus, intuitively speaking, molecules must contain some information on their index m .⁹ Since there are $M! = e^{M \log M + O(M)}$ permutations, this information exactly pertains to the rate loss term $-\beta^{-1}(1 - \pi_\alpha(0))$. This argument, however, is not complete on its own, since it is possible that larger mutual information is achievable by statistically dependent molecules. The key observation of [40], which was further developed in [25], is that one can maximize over the statistical dependency between the molecules, and under some conditions, independent molecules do maximize the mutual information of the DNA channel. To intuitively demonstrate this phenomenon, we consider the most simplistic case of $M = 2$ input molecules, $N = 2$ output molecules and $L = 1$, while assuming that each of the two molecules is sampled exactly once $S_0 = S_1 = 1$ (so $\pi_\alpha(0)$ can be set to 0). On the one hand, independent molecules $X_0, X_1 \sim P_X$, lead to the sum of mutual information terms, but since index information must also be sent, the total rate is $2I(P_X, W) - \beta^{-1}$. On the other hand, choosing fully dependent molecules $X_0 = X_1$ reduces the mutual information to $I(P_X, W^{\oplus 2})$ (since the two outputs can be considered the output of the binomial channel $W^{\oplus 2}$ for input $X = X_0 = X_1$), but trivially does not require index information. Whenever the former rate is larger than the later, to wit,

$$2I(P_X, W) - \beta^{-1} > I(P_X, W^{\oplus 2}), \quad (26)$$

or, equivalently $\beta > 1/\text{CID}(P_X, W)$, the independent inputs are optimal. The similarity of this condition to the ones appearing in the excess term (22) is not coincidental, and indeed the origin of this condition can be traced to similar derivations.

Naturally, the actual argument of [25], [40] is much more delicate, specifically regarding the statistical dependencies between the M molecules, and they rely on the Hamming distance between either output molecules (in [40]) or input molecules (in [25]) to quantify this dependency.¹⁰ If the Hamming distance between a pair of

⁹Then, with this indexing information included, the molecules are not identically distributed anymore.

¹⁰Our argument will extend the *input*-molecule based distance.

molecules, say, X_0^L and X_1^L is $\rho_{\text{H}}(X_0^L, X_1^L) = \gamma L$ with probability 1, then the molecules are “far” apart, in the sense that the mutual information they induce is approximately as for independent inputs. Otherwise, they are “close” and the mutual information they induce is approximately as for identical inputs. The constant $\gamma > 0$ is channel dependent, and for the BSC(w) considered in [25], [40], is given by $\gamma = 4w(1 + o(1))$.

Our proof argument mainly deviates from [25], [40] in the definition of the distance between molecules (Appendix B-B), which in general, is no longer the Hamming distance. It is defined in terms of probabilities of *conditional typical sets* [11, Ch. 2], which are reviewed in Appendix B-A.¹¹ By its construction, the conditional typical set $\mathcal{T}_L([W] | x_0^L)$ of $x_0^L \in \mathcal{X}^L$ is a subset of \mathcal{Y}^L for which the random output Y^L to the input x_0^L (over the channel W^L) belongs to with high probability. Our distance definition is chosen so that if x_1^L is “far” from x_0^L and x_1^L is the input to the channel W^L , then the conditional typical set $\mathcal{T}_L([W] | x_1^L)$ no longer has high probability. On the other hand, if x_1^L is “close” to x_0^L by our definition, then $\mathcal{T}_L([W] | x_1^L)$ has high probability (in fact, still possibly exponentially small, but with a negligible exponent). Our definition of distance allows to sharply characterize this property (Lemma 23). The key point, however, is that under our distance function, the distance required to create a distinction between “far” and “close” molecules in terms of the resulting mutual information, is *sub-linear* in L . This is much smaller compared to the γL Hamming distance of [25], [40] (for the BSC case). On top of that, the analysis of general sequencing channels, rather than BSCs or symmetric channels in [25], [40], leads to various technical difficulties which our proof handles. In the analysis of BSCs under Hamming distance between molecules in [25], [40], it holds in various parts of the proof that an i.i.d. uniform $P_X = (\frac{1}{2}, \frac{1}{2})$ input distribution is extremal, which in turn reduces the analysis to “single-letter” arguments. Here, under the distance function we consider, this is not true in general (*a priori* not even for symmetric channels), and the arguments include analysis of probability distributions over L -dimensional vectors (molecules). Thus, to obtain the single-letter expression (24) two stages of “single-letterization” are required (from ML to L and from L to 1). Of course, for asymmetric channels, even the final, single-letter bound (24), is not necessarily maximized by the uniform input distribution. In fact, *a priori*, larger mutual information can be obtained by assigning different input distributions to different molecules. These are the main difficulties associated with using our distance function.¹²

Proof outline: The proof of Theorem 10 appears in Appendix B. Since it is fairly complicated, we next provide a proof outline.

In Appendix B-A, we set notation conventions and definitions of conditional typical sets, and briefly state their defining property – they asymptotically obtain high conditional probability, and have cardinality given by the exponent of the conditional entropy.

In Appendix B-B, we introduce our distance function and its implications. First, we show its main defining

¹¹The notation in Appendix B-B is slightly different as the discussion there is general, and not necessarily pertains only to the DNA channel.

¹²Beyond the technical issues associated with general sequencing channel, which are handled, as usual, with method of types arguments.

property – the probability of a typical set $\mathcal{T}_L([W] | x_0^L)$ when the channel input is x_1^L , under both cases of “close” and “far” x_0^L and x_1^L . Second, we consider a large set of molecules which are pairwise “far” apart, and assume that each of these molecules is sequenced over a DMC, and that the resulting output molecules are arbitrarily permuted. We show that an observer of both the input and the output molecules, can gain information on the permutation, in the sense that its equivocation given the input and output is negligible compared to its unconditional entropy. This result refines a similar result in [40, proof of Lemma 3]. Third, we estimate the mutual information for a pair of *close* input molecules under our distance definition. We show that this mutual information behaves asymptotically as if the two input molecules are identical, and thus strictly smaller compared to the mutual information achieved by two independent input molecules (we refer to this as deficit in the mutual information).

In Appendix B-C, we show that capacity-achieving codebooks can be assumed to have, without loss of generality (w.l.o.g.), two simplifying structural properties. Both these properties state that all the codewords can have the same structure. The first one is that the codebook \mathcal{C}_M is such that all $\{x_m(j)\}_{j \in [C_M]}$ have the same type $P_{X,m} \in \mathcal{P}_L(\mathcal{X})$ (but the type may change with the molecule index m). The second one is related to the distances between the molecules. Following [25], [40], we partition $[M]$ to two subsets for each codeword $x^{LM}(j)$. In the first subset, the molecules are pairwise far, and each molecule in the second subset has a close neighbor in the first subset. The structural property shows that the subset can be the same for all codewords in the codebook. These two structural properties allows us to simplify the derivation in the next section.

In Appendix B-D, we upper bound the mutual information. We follow the idea of [25], and consider a genie-aided decoder which is capable of clustering its outputs. That is, the decoder knows which output molecules are the result of sequencing the same input molecule, but it does not know which input molecule belongs to which cluster. Specifically, we may assume that it knows $\Sigma(U^N) = (\Sigma(U_0), \Sigma(U_1), \dots, \Sigma(U_{N-1}))$ where $\Sigma: [M] \rightarrow [M]$ is a random permutation drawn from the symmetric group \mathfrak{S}_M , which is unknown to the decoder. There are M such output clusters, which we denote by \tilde{Y}^{LM} (some of them may be empty), and instead of upper bounding $I(X^{LM}; Y^{LM})$ we upper bound $I(X^{LM}; \tilde{Y}^{LM})$. The bounding of $I(X^{LM}; \tilde{Y}^{LM})$ is done at three stages.

At the first stage, we assume a fixed composition codebook, in which all molecules have exactly the same type, that is $P_{X,m} = P_X$ for all $m \in [M]$, and condition on a fixed amplification vector $Q^{N+1} = q^{N+1}$. We decompose

$$I(X^{LM}; \tilde{Y}^{LM}) \approx H(\tilde{Y}^{LM}) - H(\tilde{Y}^{LM} | X^{LM}, \tilde{U}^M) + H(\tilde{U}^M | X^{LM}, \tilde{Y}^{LM}) - M \log M \quad (27)$$

[see (B.144) for exact statement]. As in [25], [40], the bound is based on balancing between “close” and “far” molecules. That is, using the structural property of the codebook from Appendix B-C we hypothesize that the first subset has M_ρ molecules which are all far apart, and the second subset has a close molecule in the first. Then, we

utilize the results of Appendix B-B to bound these terms. Specifically, the term $H(\tilde{Y}^{LM}) - H(\tilde{Y}^{LM} | X^{LM}, \tilde{U}^M)$ loosely represents the mutual information obtained \tilde{U}^M is known,¹³ and can be upper bounded using the far/close property of the molecules, and our characterization that close molecules lead to a deficit in the mutual information. The term $H(\tilde{U}^M | X^{LM}, \tilde{Y}^{LM})$ represents the equivocation of a permutation given the input and the output of a permuting channel. For the first subset, in which molecules are far, this equivocation can be bounded using the properties derived in Appendix B-B. At the second stage, we still assume a fixed composition codebook, but bound the average mutual information over Q^{N+1} . As in the proof of the lower bounds, here the Poissonization effect of the multinomial is utilized. At the third stage, we remove the fixed composition assumption, and allow $P_{X,m}$ to vary with m , yet show that identical $P_{X,m}$ for all $m \in [M]$ does not asymptotically limit the mutual information. The order of these steps is crucial – loosely speaking, an argument based on less stages would lead to an upper bound on the mutual information in which the input distribution can be optimized separately for any given binomial channel order, to wit

$$\sum_{d \in \mathbb{N}^+} \max_{P_X^{(d)} \in \mathcal{P}(\mathcal{X})} \pi_\alpha(d) \cdot \left[I(P_X^{(d)}, W^{\oplus d}) + \Omega_d(\beta, P_X^{(d)}, W) \right] - \frac{1}{\beta} (1 - \pi_\alpha(0)). \quad (28)$$

Such a bound is clearly loose since the encoder of the DNA channel does not know S_m – how many times each molecule is sampled by the channel. Finally, using this upper bound in the Fano's-inequality based argument completes the proof.

The gap between the upper and the lower bound on the capacity: The upper bound of Theorem 10 and the lower bound of Theorem 5 match in case $\Omega_d(\beta, P_X, W) = 0$ for all $d \in \mathbb{N}^+$, for the maximizing input distribution of (24). Specifically, it holds that there exists a critical value for the molecule length parameter β_{cr} such that the capacity is known for all $\beta > \beta_{cr}$, as follows:

Corollary 11. *Let*

$$P_X^*(\alpha, \beta, W) \in \arg \max_{P_X \in \mathcal{P}(\mathcal{X})} \sum_{d \in \mathbb{N}^+} \pi_\alpha(d) \cdot \left[I(P_X, W^{\oplus d}) + \Omega_d(\beta, P_X, W) \right] \quad (29)$$

and let

$$\beta_{cr}(\alpha, W) := \min \left\{ \beta: \beta \geq \frac{2}{\text{CID}(P_X^*(\alpha, \beta, W), W)} \right\} \quad (30)$$

Then, for all $\beta \geq \beta_{cr}(\alpha, W)$

$$C(\text{DNA}) = \sum_{d \in \mathbb{N}^+} \pi_\alpha(d) \cdot I \left(P_X^*(\alpha, \beta_{cr}(\alpha, W), W), W^{\oplus d} \right) - \frac{1}{\beta} (1 - \pi_\alpha(0)). \quad (31)$$

Proof: It is evident from (22) that for tightness of the lower and upper bounds on capacity, it must hold

¹³Though note that the first entropy term is $H(\tilde{Y}^{LM})$ and not $H(\tilde{Y}^{LM} | \tilde{U}^M)$.

that

$$\beta \geq \max_{d \in \mathbb{N}^+} \frac{2}{\text{CID}(P_X^*, W^{\oplus d})} = \frac{2}{\text{CID}(P_X^*, W)} \quad (32)$$

where the equality follows since $\text{CID}(P_X, W^{\oplus d})$ is monotonic increasing in d (See Corollary 26). It is also evident from (22) that if (32) holds for the maximizer of

$$\max_{P_X \in \mathcal{P}(\mathcal{X})} \sum_{d \in \mathbb{N}^+} \pi_\alpha(d) \cdot \left[I(P_X, W^{\oplus d}) + \Omega_d(\beta, P_X, W) \right] \quad (33)$$

then it holds for any larger β . Indeed, in (22), whenever β is increased the set $\{P_X: \text{CID}(P_X, W^{\oplus d}) \geq \frac{2}{\beta}\} \subset \mathcal{P}(\mathcal{X})$ expands, while the excess-rate value at the other two regimes, to wit $\frac{1}{\beta}$ and $-\text{CID}(P_X, W^{\oplus d}) + \frac{2}{\beta}$ decreases. This implies that the value of (33) is fixed for all $\beta > \beta_{\text{cr}}(\alpha, W)$, which directly leads to the capacity expression (31). ■

Remark 12. Note that both sides of the inequality in the definition of the critical value of β in (30) depend on β . Thus, the critical value of β is, in fact, a solution to a fixed point equation. If we consider the simpler solution $P_X^{**} \in \arg \max_{P_X \in \mathcal{P}(\mathcal{X})} \sum_{d \in \mathbb{N}^+} \pi_\alpha(d) \cdot I(P_X, W^{\oplus d})$, then it clearly holds that both P_X^* and P_X^{**} achieve capacity for all $\beta > \beta_{\text{cr}}$, however, it does not seem to hold, in general, that $\beta_{\text{cr}}(\alpha, W)$ equals $\frac{2}{\text{CID}(P_X^{**}, W)}$. To see this, consider for example, $\bar{d} = 1$, that is, a single term in the sum of (24). It may hold that $\beta > \frac{2}{\text{CID}(P_X^{**}, W)}$ but there exists \tilde{P}_X for which $\text{CID}(\tilde{P}_X, W^{\oplus d}) < \frac{1}{\beta}$ and

$$I(\tilde{P}_X, W) + \Omega_1(\beta, \tilde{P}_X, W) > I(P_X^{**}, W) + \Omega_1(\beta, P_X^{**}, W). \quad (34)$$

So P_X^{**} does not attain the maximum of (24) for this β , and it is required to solve (30) (with equality sign replacing inequality) in order to find the critical β .

Prospective refinement of the upper bound: In general, the upper bound of Theorem 10 and the lower bound of Theorem 5 do not match, and one may wonder if the upper bound of Theorem 10 can be improved. We next discuss a possible method to refine the upper bound of Theorem 10. Recall that the CID is defined by a common input to a *pair* of channels, and indeed, the proof of the upper bound is based on considering the loss in capacity due to *pairs* of “close” molecules, according to the defined distance. It seems plausible that by considering the mutual information loss of *triplets* of molecules, which are “close” according to a proper definition of scattering of triplets [defined in a way that generalizes the distance between pairs of molecules in Appendix B-B, see (B.10)] would lead to more lenient constraints, and will show that the lower and upper bounds match even when (32) does not hold. A similar comment applies to quadruplets, quintuplets, and so on, of molecules can be considered and improve the bound. It is conceivable, however, that the intricacy of the details required in such a proof method greatly outweighs their effectiveness in improving the bound.

The assumption on maximal log-likelihood ratio: Our converse result requires that the maximal log-likelihood ratio of the sequencing channel $\nu_{\min}(W)$ is finite. The source of this assumption is an application

of the *blowing-up lemma* [11, Ch. 5] [29], [30] [37, Lemma 3.6.1] in the proof (see Appendix B-B3, proof of Lemma 28). This assumption precludes our result for being applicable for a binary erasure channel (BEC) sequencing channel, for example. While this is merely a technical assumption, it is not obvious that it can be removed. The reason is that for channels with unbounded $\nu_{\min}(W)$, the ordering of the output molecules seems to be an easier task. For example, in a BEC, even a disagreement in a single bit of a candidate pair of input and output molecules reveals that this output molecule is not a sequencing of the input molecule. As discussed, the implicit necessity to order the molecules affects capacity. Thus, an upper bound on the capacity for such channels remains an open problem.

V. MODULO-ADDITIVE SEQUENCING CHANNELS

In this section, we consider sequencing channels which are *modulo-additive*, whose most notable special case is the BSC. For such channels, $\mathcal{X} = \mathcal{Y} = [|\mathcal{X}|]$ and the input-output relationship for each symbol can be written as

$$Y = X \oplus Z, \quad (35)$$

where Z is independent of X and \oplus denotes addition modulo $|\mathcal{X}|$. The channel transition function, $W(y | x)$, is determined by the p.m.f. of Z . When $\mathcal{X} = \{0, 1\}$ the modulo-additive channel is the BSC with crossover probability $w := \mathbb{P}[Z = 1]$. The modulo-additive channel is symmetric and so the unique capacity achieving input distribution is uniform. Furthermore, per Prop. 38 (Appendix C-A), its binomial extension is also symmetric. For modulo-additive channels, the sufficient condition for the upper and lower bounds to coincide is simplified as follows:

Proposition 13. *Let $P_X^{(\text{unif})}$ be the uniform distribution over \mathcal{X} , and let*

$$\beta_{\text{cr}}^{(\text{unif})}(\alpha, W) := \frac{2}{\text{CID}(P_X^{(\text{unif})}, W)}. \quad (36)$$

Then, for all $\beta > \beta_{\text{cr}}^{(\text{unif})}(\alpha, W)$ the capacity of the DNA channel with modulo-additive sequencing channel W is given by

$$C(\text{DNA}) = \sum_{d \in \mathbb{N}^+} \pi_\alpha(d) \cdot I(P_X^{(\text{unif})}, W^{\oplus d}) - \frac{1}{\beta} (1 - \pi_\alpha(0)). \quad (37)$$

The proof of Prop. 13 appears in Appendix C-B. We next consider the BSC case, and compare our result with that of [25, Theorem 1]:

Example 14 (Critical β for BSCs). Consider the BSC with crossover probability w . The results of [25, Theorem 1] and [26, Theorem 1] combined show that under the condition $w < 1/8$, the right-hand side (r.h.s.) of (37) is

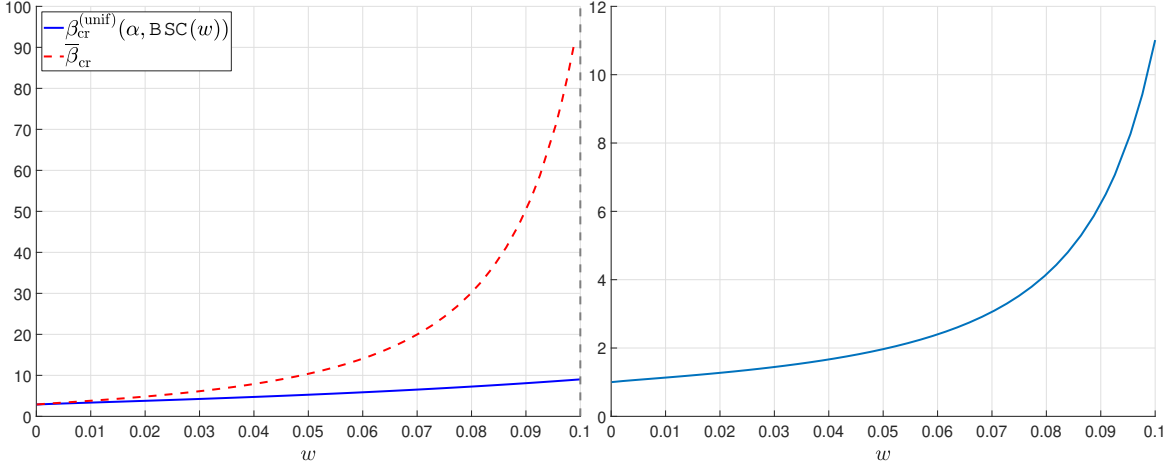

Figure 2. Comparison between [25, Theorem 1] and Prop. 13 for BSC. Left – $\beta_{\text{cr}}^{(\text{unif})}(\alpha, \text{BSC}(w))$ and $\bar{\beta}_{\text{cr}}$ from [25, Theorem 1]. Right – the ratio $\bar{\beta}_{\text{cr}}/\beta_{\text{cr}}^{(\text{unif})}(\alpha, \text{BSC}(w))$.

the capacity for all¹⁴

$$\beta > \bar{\beta}_{\text{cr}} := \frac{2}{\log 2 - h_b(4w)}. \quad (38)$$

Similar restrictions on (β, w) have appeared in [40]. Here, Prop. 13 implies that the r.h.s. of (37) is the capacity as long as

$$\beta \geq \beta_{\text{cr}}^{(\text{unif})}(\alpha, \text{BSC}(w)) = \frac{2}{\log 2 - h_b(w * w)} = \frac{2}{\log 2 - h_b(2w(1-w))} \quad (39)$$

where $\text{CID}(P_X^{(\text{unif})}, W) = \text{CID}((1/2, 1/2), \text{BSC}(w)) = \log 2 - h_b(w * w) = \log 2 - h_b(2w(1-w))$ (where $*$ is the binary convolution operator). Note that there is no restriction on w , and that $\beta_{\text{cr}}^{(\text{unif})}(\alpha, \text{BSC}(w))$ is finite for any $w \in (0, \frac{1}{2})$ (though approaches ∞ as $w \uparrow \frac{1}{2}$). Fig. 2 numerically compares the $\beta_{\text{cr}}^{(\text{unif})}(\alpha, \text{BSC}(w))$ with $\bar{\beta}_{\text{cr}}$.

VI. A NUMERICAL EXAMPLE

In general, all the bounds in this paper can be computed efficiently, and a discussion on computational aspects of the bound appears in Appendix D. To exemplify our results, we consider an alphabet \mathcal{X} of size $|\mathcal{X}|=4$, which is suitable to a practical DNA channel. For simplicity, we also set $|\mathcal{Y}|=4$ and consider the sequencing DMC

$$W_0(y | x) = \frac{1}{100} \cdot \begin{bmatrix} 94 & 2 & 2 & 2 \\ 2 & 70 & 25 & 3 \\ 3 & 2 & 85 & 10 \\ 10 & 5 & 5 & 80 \end{bmatrix}, \quad (40)$$

which is an asymmetric channel. We assume $\alpha = 5$ and truncate our bounds with $\bar{d} = 20$, so that the truncation error is less than 10^{-6} . The maximization over P_X for the upper and lower bounds is performed in two steps:

¹⁴Note that here we use nats rather than bits. Thus here $\beta = \frac{L}{\log_e M}$ whereas in [25, Theorem 1] the notation used is $\frac{1}{\beta} = \frac{L}{\log_2 M}$. The next condition takes this unit scaling and inverted definition into consideration.

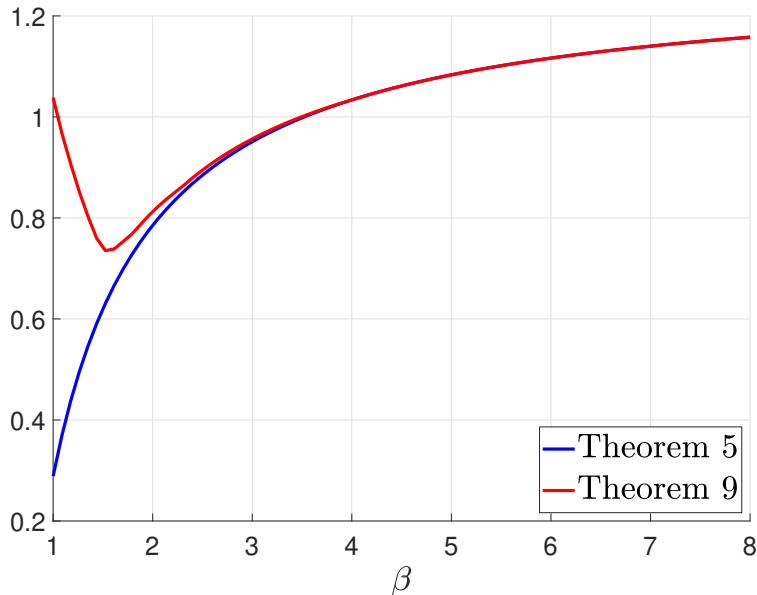

Figure 3. Upper and lower bounds on $C(\text{DNA}(5, \beta, W_0))$ as a function of β (in nats).

First, a grid search over the $(|\mathcal{X}|-1)$ -dimensional simplex, with an accuracy of 10^{-1} (that is $P_X \in \mathcal{P}_{10}(\mathcal{X})$) and then refining the result using Matlab’s `fmincon` function (with its default interior-point algorithm). The capacity lower and upper bounds for various values of β is plotted in Fig. 3. For low values of β (about $\beta \lesssim 1.6$) the upper bound is not monotonic increasing in β (as might be expected from the true capacity), and is most likely off at this regime. For larger values, $1.6 \lesssim \beta \lesssim 3$ the upper bound is monotonic increasing and is slightly above the lower bound. For $\beta \gtrsim 3.5$ the distinction between the bounds is indiscernible.

In Fig. 4 we plot the lower bound on the reliability function, for $\alpha = 5$, various values of β , and using a truncation of $\bar{d} = 10$. For simplicity of computation, we do not optimize over P_X , but rather use the uniform P_X . The advantage of using a larger β on the reliability function is easily observed.

VII. SUMMARY AND OPEN PROBLEMS

In this paper we have derived lower and upper bounds on the capacity of the memoryless sequencing channel. In terms of lower bounds, we show that the lower bound which was only known for BSC (or symmetric) sequencing channels, and is restricted to a partial regime of the molecule length parameter β and the channel noise, holds in fact for general DMCs and without any restrictions. We have shown that this bound is achievable by a universal decoder, and obtained asymptotic bounds on its error probability. This has revealed that the DNA channel suffers from *outage*: The random amplification vector Q^{N+1} is a measure of the quality of the channel, in terms of the conditional mutual information it induces. When the mutual information is larger than the required coding rate, the error probability decays fast – exponentially w.r.t. scaling $K_M = ML = \beta M \log M$. However, the probability that Q^{N+1} is such that the required coding rate is not supported, the error probability

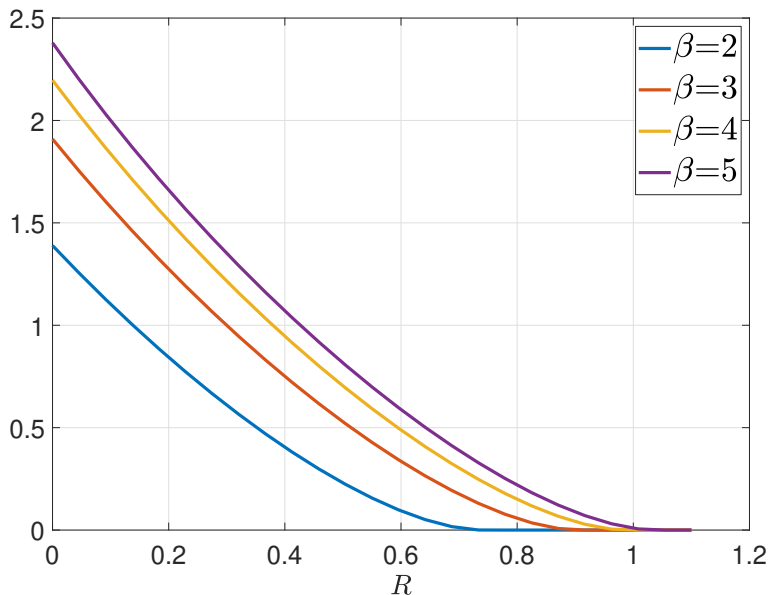

Figure 4. Lower bound on the reliability function $E^*(R, \text{DNA}(5, \beta, W_0), \{M\})$ as a function of R (in nats).

is large.¹⁵ Our bound on the probability of such events is exponential w.r.t. scaling $K_M = M$ and so this is the dominant error event. In terms of upper bounds (converse), we have refined the analysis of [25], [40] by introducing of a general distance function between molecules. This resulted a tighter upper bound, which agrees with the lower bound for a larger regime of β and W .

The following problems remain open for the memoryless sequencing channel:

1) Matching lower and upper bounds: It is tempting to conjecture that the lower bound of Theorem 5 is the true capacity for any β and W . This implies that the upper bound of Theorem 10 is the one to be tightened. However, as we have discussed after Theorem 10, it is conceivable that we have pushed the capability of the converse arguments of [25], [40] to their maximum, at least assuming reasonably complicated arguments.¹⁶ Hence, it is of interest to find proof arguments of substantially different nature that would be capable of establishing capacity in the high-noise/low β regime.

2) Upper bounds on the reliability function: The lower bound derived here (Theorem 8) is based on an analysis of the molecule duplicate vector $S^M \in [N]^M$. In the proof of the lower bond, the multinomial distribution of S^M – for which the components S_m are identically distributed but statistically dependent – is replaced by $\tilde{S}^M \in [N]^M$ which follows an i.i.d. Poisson distribution $\text{Pois}(\alpha)$. This facilitates the analysis, but may not be tight. Specifically, the analysis Lemma 20 is not tight in general. As an illustrative example, in the Poisson model, the probability that none of the molecules is sampled is given by

$$\mathbb{P} \left[\bigcap_{m \in [M]} \tilde{S}_m = 0 \right] = (1 - e^{-\alpha})^M = e^{-M \log(1 - e^{-\alpha})}. \quad (41)$$

¹⁵At least, we do not have a non-trivial bound for it.

¹⁶Except perhaps, for the possibility of considering groups of molecules larger than pairs – as discussed after Theorem 10.

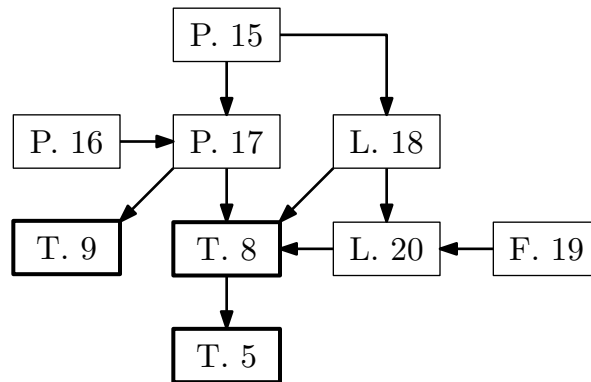

Figure 5. Roadmap for the proofs of the lower bounds (achievability). The used abbreviations are Lemma (L.), Proposition (P.), Theorem (T.) and Fact (F.). The result at the tail of an arrow is utilized to prove the result pointed by its head.

This probability is exponential w.r.t. M and thus affect the exponential decay of the error probability at this scale. For example, $E^*(R) \leq \log(1 - e^{-\alpha})$ because the error probability is large if none of the molecules have been sampled. By contrast, in the true multinomial model $\mathbb{P}[\cap_{m \in [M]} S_m = 0] = 0$. It is therefore of interest to find tight tails bounds on the multinomial S^M , and utilize them to obtain upper bounds on the reliability function.

3) Tight finite blocklength bounds: Finite length bounds are of specific interest in this problem, since the second-order terms in this problem vanish very slow. In our arguments, the decay rate is either $O(\frac{1}{\log M})$ and occasionally or even $O(\frac{\log \log M}{\log M})$. This seems to be an inherent aspect of the problem. For example, consider a basic model in which $M = M$, each molecule is sampled exactly once (with probability 1), and the sequencing channel is noiseless. Then, the capacity is the normalized logarithm of the possible number of sequences. The stars and bars model (see footnote 17) implies that its capacity is $\frac{1}{ML} \log \binom{M+M^\beta-1}{M}$, which by standard approximation of the binomial coefficient is $1 - \frac{1}{\beta} + O(\frac{1}{\log M})$.

ACKNOWLEDGMENT

The advice of Ido Tal regarding the computation of the bounds is acknowledged with gratitude.

APPENDIX A

PROOFS OF LOWER BOUNDS

In this section, we prove the lower (achievability) bounds. A roadmap for the various results proved is provided in Fig. 5.

Based on Theorem 8, the proof of Theorem 5 is short and standard. Thus, we provide it here before the proof of Theorem 8, assuming the latter holds.

Proof of Theorem 5: Let an arbitrary input distribution, $P_X \in \mathcal{P}(\mathcal{X})$, be given. By the strict positivity of the binary KL divergence $d_b(p \parallel q) > 0$ for all $p \neq q$

$$\sum_{d \in \mathbb{N}} \left(1 - \sum_{i \in [d]} \theta_i \right) \cdot d_b \left(\frac{\theta_d}{1 - \sum_{i \in [d]} \theta_i} \parallel \pi_{\alpha|\geq d}(d) \right) \geq 0, \quad (\text{A.1})$$

and a simple calculation shows that equality holds if and only if $\theta_d = \pi_\alpha(d)$ for all $d \in \mathbb{N}^+$. Let R be given so that

$$R < \sum_{d \in \mathbb{N}} \pi_\alpha(d) \cdot I(P_X, W^{\oplus d}) - \frac{1}{\beta}(1 - \pi_\alpha(0)). \quad (\text{A.2})$$

Since $\{\pi_\alpha(d)\}$ does not belong to the feasible set (16) of the minimization (15), it holds that $E^*(R, \text{DNA}, \{M\}) > 0$. Hence, there exists a sequence of codes-decoders $(\mathcal{C}_M, \mathcal{D}_M)$ so that the average error probability satisfies

$$\frac{1}{|\mathcal{C}_M|} \sum_{j \in [|\mathcal{C}_M|]} \text{pe}(\mathcal{C}, \mathcal{D} \mid x^{LM}(j)) \leq e^{-\Theta(M)}. \quad (\text{A.3})$$

A similar bound can be proved for the maximal error probability for a codebook of rate slightly smaller, say $R - \delta$, for some $\delta > 0$ (and all M sufficiently large) by expurgating half of the codewords from each codebook with the largest $\text{pe}(\mathcal{C}, \mathcal{D} \mid x^{LM}(j))$. Thus, $R - \delta$ is an achievable rate for any $\epsilon \in (0, 1)$ and so the lower bound on capacity follows. \blacksquare

A. Preliminaries: Sampling Type Classes

Recall that at the sampling stage, the pool of L molecules $\{x_m^L\}_{m \in [M]}$ is sampled N times, where $u^N \in [M]^N$, the molecule index vector, is such that $u_n = m$ if x_m^L is the sampled molecule at the n th sampling trial. Recall also the definitions of the molecule duplicate vector $s^M \in [N]^M$ and the amplification vector $q^{N+1} \in [M+1]^{N+1}$ from Sec. II-B. The triplet (u^N, s^M, q^{N+1}) can be described by the empirical distribution operator (2) as $s^M = \mathcal{N}(u^N)$ and $q^{N+1} = \mathcal{N}(s^M) = \mathcal{N}^{(2)}(u^N)$, and then, *sampling type classes* can be defined as follows: The *molecule index type class* of s^M is defined as

$$\mathcal{T}_{s^M} := \{u^N \in [M]^N : \mathcal{N}(u^N) = s^M\}, \quad (\text{A.4})$$

and the *molecule duplicate type class* of a q^{N+1} is defined as

$$\mathcal{T}_{q^{N+1}} := \{s^M \in [N]^M : \mathcal{N}(s^M) = q^{N+1}\}. \quad (\text{A.5})$$

In a similar fashion, we define the *amplification type class* as

$$\mathcal{T}_{q^{N+1}}^{(2)} := \{u^N \in [M]^N : \mathcal{N}^{(2)}(u^N) = q^{N+1}\}. \quad (\text{A.6})$$

Let

$$\mathcal{Q}(M, N) := \left\{ q^{N+1} \in [M+1]^{N+1}: \sum_{d \in [N+1]} q_d = M, \sum_{d \in [N+1]} dq_d = N \right\} \quad (\text{A.7})$$

be the set of all valid amplification vectors for M input molecules and N output molecules. The next proposition provides a tight asymptotic scaling of the sizes of the molecule index type class, the molecule duplicate type class, and the amplification type class. This will be used in the proofs of the lower bounds on capacity and reliability function.

Proposition 15. For a coverage depth $\alpha = \frac{N}{M} > 0$:

- 1) The number of types is bounded as $|\mathcal{Q}(M, N)| \leq e^{[1+o(1)]\sqrt{\frac{2\pi^2}{3}M}}$.
- 2) The size of the amplification type class is

$$|\mathcal{T}_{q^{N+1}}^{(2)}| = \exp \left[\left(1 - \frac{q_0}{M}\right) \cdot M \log M + \epsilon_M \cdot M \right] \quad (\text{A.8})$$

where $|\epsilon_M| \leq \log \alpha^2 e$.

Proof: ■

1) It is evident that each q^{N+1} uniquely defines a restricted *partition* of N to at most $M = \frac{N}{\alpha}$ summands (a bijection can be defined between $q^{N+1} \in \mathcal{Q}(M, N)$ and a restricted partition). For example, $q^{N+1} = (M-5, 2, 2, \dots, 0, \underbrace{1}_{q_{N-6}}, \dots, 0, 0)$ corresponds to the partition $N = 1 + 1 + 2 + 2 + (N-6)$. The number of restricted partitions is asymptotically bounded as claimed by the celebrated analysis of Hardy and Ramanujan, Uspensky, and Rademacher [2, Ch. 5].

2) Let s^M and q^{N+1} be such that $\mathcal{N}(s^M) = q^{N+1}$. The exact value of $|\mathcal{T}_{q^{N+1}}|$ and $|\mathcal{T}_{s^M}|$ can be easily derived, and then $|\mathcal{T}_{q^{N+1}}^{(2)}|$ is evaluated by $|\mathcal{T}_{q^{N+1}}^{(2)}| = |\mathcal{T}_{q^{N+1}}| \cdot |\mathcal{T}_{s^M}|$. The size of $\mathcal{T}_{q^{N+1}}$ is the number of unique permutations of the vector

$$\underbrace{(0, 0, \dots, 0)}_{q_0}, \underbrace{1, 1, \dots, 1}_{q_1}, \dots, \underbrace{d, d, \dots, d}_{q_d}, \dots \in [N+1]^M \quad (\text{A.9})$$

given by

$$|\mathcal{T}_{q^{N+1}}| = \binom{M}{q_0, q_1, \dots, q_N} = \frac{M!}{\prod_{d=0}^N q_d!}. \quad (\text{A.10})$$

It similarly holds that that size of \mathcal{T}_{s^M} is

$$|\mathcal{T}_{s^M}| = \binom{N}{s_0, s_1, \dots, s_{M-1}} = \frac{N!}{\prod_{m=0}^{M-1} s_m!} = \frac{N!}{\prod_{d=0}^N (d!)^{q_d}}, \quad (\text{A.11})$$

where the last equality holds by the definition $q^{N+1} = \mathcal{N}(s^M)$. To prove the claimed upper bound we first bound $|\mathcal{T}_{s^M}|$ by the number of ways to choose each of the N entries of u^N from a set of possible $M - q_0$

molecules (without taking into account any other constraints on its empirical distribution). Thus

$$|\mathcal{T}_{s^M}| \leq N^{M-q_0}. \quad (\text{A.12})$$

To bound the size of $\mathcal{T}_{q^{N+1}}$, let $\theta_d := \frac{q_d}{M}$ so that $\theta = (\theta_0, \dots, \theta_N)$ is a p.m.f., and since $\sum_{d \in [N+1]} dq_d = N$ then $\sum_{d \in [N+1]} d\theta_d = \alpha$ must hold. Let $H(\theta) := -\sum_{d \in [N+1]} \theta_d \log \theta_d$ be the entropy of θ . Then,

$$|\mathcal{T}_{q^{N+1}}| \stackrel{(a)}{\leq} \exp[M \cdot H(\theta)] \stackrel{(b)}{\leq} \exp[M \cdot \log \alpha e] \quad (\text{A.13})$$

where (a) is by the standard exponential upper bound of the multinomial coefficient with the entropy being the exponent (just as bounding the type class size in ordinary method of types [11, Lemma 2.3]), and (b) is by upper bounding $H(\theta)$ by the maximum entropy under the mean constraint α [11, Lemma 3.12 and Corollary 3.12] (it is easy to verify and well-known that the maximum entropy p.m.f. in this case is geometric). Hence, $|\mathcal{T}_{q^{N+1}}| \leq e^{\Theta(M)}$. Combining (A.13) with (A.12) and $N = \alpha M$ results in

$$|\mathcal{T}_{q^{N+1}}^{(2)}| = |\mathcal{T}_{q^{N+1}}| \cdot |\mathcal{T}_{s^M}| \leq e^{(M-q_0) \log N + \Theta(M)} = e^{(M-q_0) \log M + \Theta(M)}. \quad (\text{A.14})$$

To prove the claimed lower bound, let $\sigma_m := \frac{s_m}{N}$, so that $\sigma = (\sigma_0, \dots, \sigma_{M-1})$ is a p.m.f.. Here we lower bound $|\mathcal{T}_{s^M}|$ by the exponent of the entropy $H(\sigma)$, divided by a factor which will be shown to be $e^{\Theta(M)}$. The proof is almost identical to the one used to lower bound the size of the type class (a multinomial coefficient) in the standard method of types: Considering σ as the empirical type of $u \in [M]^N$ – an N dimensional vector from alphabet of size M – the exact number of possible types is $\binom{N+M-1}{M-1}$ (this follows from the stars and bars model¹⁷. See, also, e.g., [11, Ex. 2.1]). Then, the standard estimate on a type class size [8, Thm. 11.1.3] [11, Lemma 2.3] implies that¹⁸

$$|\mathcal{T}_{s^M}| \geq \frac{1}{\binom{N+M-1}{M-1}} \exp[N \cdot H(\sigma)]. \quad (\text{A.15})$$

By the standard entropy bound on the binomial coefficient

$$\binom{N+M-1}{M-1} \leq e^{(N+M-1) \cdot h_b(\frac{M}{N+M})} \leq e^{(\alpha+1)M \cdot h_b(\frac{1}{\alpha+1})} = e^{\Theta(M)} \quad (\text{A.16})$$

an so continuing (A.15)

$$|\mathcal{T}_{s^M}| \geq \exp[N \cdot H(\sigma) - \Theta(M)] \geq \exp[N \cdot \min H(\zeta) - \Theta(M)] \quad (\text{A.17})$$

¹⁷The stars and bars model: Let $a, n, k \in \mathbb{N}^+$ such that $n \geq k$ and $n > ak$. The number of ways to distribute n stars into k different bins (i.e., the number of integer solutions (x_0, \dots, x_{k-1}) to $\sum_{i \in [k]} x_i = n$) such that $x_i \geq a$ for all $i \in [k]$ is $\binom{n-k(a-1)-1}{k-1}$.

¹⁸In the stated results in both [8, Thm. 11.1.3] and [11, Lemma 2.3], as well as in their proofs, the pre-exponent is given by the inverse of $(N+1)^M$, the latter being an *upper* bound to the exact value $\binom{N+M-1}{M-1}$. Such a bound is useful in the standard method of types, since in that analysis $N \rightarrow \infty$ while the alphabet size is $M = \Theta(1)$. Here $M \rightarrow \infty$ and $N = \alpha M = \Theta(M) \rightarrow \infty$ and so a different bound is required. Nonetheless, the proof itself carries over verbatim, except for replacing the bound $(N+1)^M$ with the exact value $\binom{N+M-1}{M-1}$.

where the minimum is over p.m.f's ζ which have support of $M - q_0$. We next show that the minimal entropy is obtained at

$$\zeta^* = \frac{1}{N} \underbrace{(0, 0, \dots, 0)}_{q_0}, N - (M - q_0 - 1), \underbrace{1, 1, \dots, 1, 1, 1, 1, \dots, 1)}_{M - q_0 - 1}. \quad (\text{A.18})$$

To see this, note that any other $\tilde{\zeta}$ which is supported on exactly $M - q_0$ indices, and has entries which are integer multiples of $1/N$ is *majorized* by ζ^* [28].¹⁹ It then follows from the Schur-concavity of the entropy function that $H(\zeta^*) \leq H(\tilde{\zeta})$ [28, Ch. 3.D.1]. The resulting entropy is then

$$H(\zeta^*) = \left[\frac{N - (M - q_0 - 1)}{N} \right] \log \left[\frac{N}{N - (M - q_0 - 1)} \right] + \frac{(M - q_0 - 1)}{N} \log N \quad (\text{A.19})$$

$$\geq \frac{(M - q_0 - 1)}{N} \log N. \quad (\text{A.20})$$

Thus,

$$|\mathcal{T}_{s^M}| \geq \exp \left[N \cdot \frac{(M - q_0 - 1)}{N} \log N - \Theta(M) \right] \quad (\text{A.21})$$

$$\geq \exp [(M - q_0) \log M - \Theta(M)]. \quad (\text{A.22})$$

The proof is completed since $|\mathcal{T}_{q^{N+1}}^{(2)}| = |\mathcal{T}_{q^{N+1}}| \cdot |\mathcal{T}_{s^M}| \geq |\mathcal{T}_{s^M}|$ as $|\mathcal{T}_{q^{N+1}}| \geq 1$.

B. Preliminaries: The DNA Channel as a Mixture of Binomial Channels

In this section, we develop an alternative representation for the likelihood function of the DNA channel with a memoryless sequencing channel. In the DNA channel, each symbol in the codeword is independently sequenced a variable number of times, according to the number of times the molecule it belongs to was sampled in the sampling stage. As a result, the likelihood function of all symbols is a (random) mixture of binomial channels. In this section, we make this property explicit in the likelihood function.

Let x^{LM} be the input and y^{LN} be the corresponding output of the DNA channel. Assume, as usual, that the sampling step is such that $U_n \sim \text{Uniform}[M]$, i.i.d., independent of x^{LM} . The basic expression for the likelihood function starts from (6) and is further developed as follows:

$$\mathcal{L} [y^{LN} | x^{LM}] = \sum_{u^N \in [M]^N} \mathbb{P}[U^N = u^N] \prod_{n \in [N]} W^L [y_n^L | x_{u_n}^L] \quad (\text{A.23})$$

$$= \sum_{q^{N+1} \in \mathcal{Q}(M, N)} \sum_{s \in \mathcal{T}_{q^{N+1}}} \sum_{u \in \mathcal{T}_{s^M}} \mathbb{P}[U^N = u^N] \prod_{n=0}^N W^L [y_n^L | x_{u_n}^L] \quad (\text{A.24})$$

$$= \sum_{q^{N+1} \in \mathcal{Q}(M, N)} \sum_{s \in \mathcal{T}_{q^{N+1}}} \mathbb{P}[\mathcal{T}_{s^M}] \sum_{u \in \mathcal{T}_{s^M}} \frac{1}{|\mathcal{T}_{s^M}|} \prod_{n=0}^N W^L [y_n^L | x_{u_n}^L] \quad (\text{A.25})$$

¹⁹For any $a^K \in \mathbb{R}^K$, let $a_{\downarrow}^K \in \mathbb{R}^K$ be such that $\mathcal{N}(a^K) = \mathcal{N}(a_{\downarrow}^K)$ and the components of a_{\downarrow}^K are sorted in descending order. Then $a^K \in \mathbb{R}^K$ majorizes $b^K \in \mathbb{R}^K$ if $\sum_{i \in [k]} a_{\downarrow, i} \geq \sum_{i \in [k]} b_{\downarrow, i}$ for all $k \in [K]$.

$$= \sum_{q^{N+1} \in \mathcal{Q}(M, N)} \mathbb{P} \left[\mathcal{T}_{q^{N+1}}^{(2)} \right] \sum_{u \in \mathcal{T}_{q^{N+1}}^{(2)}} \frac{1}{|\mathcal{T}_{q^{N+1}}^{(2)}|} \prod_{n=0}^N W^L [y_n^L | x_{u_n}^L] \quad (\text{A.26})$$

where $\mathbb{P}[\mathcal{T}_{q^{N+1}}^{(2)}] = |\mathcal{T}_{q^{N+1}}^{(2)}| \cdot \mathbb{P}[U^N = u^N] = |\mathcal{T}_{q^{N+1}}^{(2)}| / M^N$.

Consider a fixed (u^N, s^M, q^{N+1}) , where $u^N \in \mathcal{T}_{s^M}$, $s^M \in \mathcal{T}_{q^{N+1}}$ and $q^{N+1} \in \mathcal{Q}(M, N)$. We next present the conditional likelihood term, $\prod_{n=0}^{N-1} W^L [y_n^L | x_{u_n}^L]$, in an alternative form, which better expresses the mixture-of-binomial nature of this channel. Specifically, in this form, the symbols of the molecules that were sampled the same number of times are grouped together. Let $K = ML$ be the total number of symbols in the codeword x^{LM} and let $a^K \in \mathcal{A}^K$ be their concatenation in an arbitrary fixed order. For concreteness, we choose the natural ordering, that is, the one which satisfies $x_0^L = (a_0, a_1, \dots, a_{L-1})$, $x_1^L = (a_L, a_{L+1}, \dots, a_{2L-1})$, etc. Given (u^N, s^M, q^{N+1}) , when a_k belongs to a molecule x_m which has been sampled d_k times, it has d_k output symbols in y^{LN} . Let $b_k^{d_k} = (b_{k,0}, \dots, b_{k,d_k-1}) \in \mathcal{Y}^{d_k}$ be those d_k output symbols, ordered according to their order in y , and let $(b^*)^K = (b_0^{d_0}, \dots, b_{K-1}^{d_{K-1}})$. It should be noted that d_k , the dimension of b_k may be different for each k , and depends on (u^N, s^M, q^{N+1}) . Furthermore, $d_k \in [N + 1]$ since the maximal number of times a single molecule can be sampled is N .²⁰

With this interpretation, we now express the likelihood function in terms of $W^{\oplus d}$, the d -order binomial extension of W (Definition 4). Specifically, we summarize the correspondence between (x^{LM}, y^{LN}) and (a^K, b^{*K}) (with $K = ML$) as follows: The molecule index vector u^N transforms an input-output pair (x^{LM}, y^{LN}) to an equivalent input-output pair (a^K, b^{*K}) and a partition $\{\mathcal{K}_d(u^N)\}_{d \in [N+1]}$ of $[K] = [ML]$ with $K_d = |\mathcal{K}_d(u^N)| = q_d L$ such that the dimension of $b_k^{d_k}$, is $d_k = d$ if and only if $k \in \mathcal{K}_d(u^N)$. For brevity, we have omitted in this notation the explicit dependency of (a^K, b^{*K}) in (x^{LM}, y^{LN}) . It thus holds

$$\mathcal{L} [y^{LN} | x^{LM}, u^N] = \prod_{d=0}^N W^{\oplus d} \left[b_{\mathcal{K}_d(u^N)}^d | a_{\mathcal{K}_d(u^N)} \right] \quad (\text{A.27})$$

and combining this with (A.26), leads to the likelihood form

$$\mathcal{L} [y^{LN} | x^{LM}] = \sum_{q^{N+1} \in \mathcal{Q}(M, N)} \mathbb{P} \left[U^N \in \mathcal{T}_{q^{N+1}}^{(2)} \right] \sum_{u^N \in \mathcal{T}_{q^{N+1}}^{(2)}} \frac{1}{|\mathcal{T}_{q^{N+1}}^{(2)}|} \prod_{d=0}^N W^{\oplus d} \left[b_{\mathcal{K}_d(u^N)}^d | a_{\mathcal{K}_d(u^N)} \right]. \quad (\text{A.28})$$

For brevity, we further simplify $\mathcal{K}_d \equiv \mathcal{K}_d(u^N)$. Furthermore, we note that the likelihood (A.27), conditioned on u^N , is determined by the joint type in the d -order binomial $a_{\mathcal{K}_d} \rightarrow b_{\mathcal{K}_d}^d$ channel given by

$$\hat{P}^d(x^{LM}, y^{LN}; u^N) := \mathcal{P}(a_{\mathcal{K}_d}, b_{\mathcal{K}_d}^d) \quad (\text{A.29})$$

for all $d \in [N + 1]$.

²⁰Which only occurs in the unlikely event that only a single molecule has been sampled N times.

C. A Universal Decoder for the DNA Channel

When the codewords are chosen under the uniform probability distribution, the optimal decoding rule in terms of error probability is the ML decoding rule. However, it is also well known that in random coding analysis of DMCs with a fixed composition ensemble, the ML rule can be replaced by the MMI rule, without degrading the random coding error exponent [10, Ch. 10] [10, Thm. IV.1]. Here, however, we will analyze the i.i.d. random coding ensemble, in which the $ML \cdot |\mathcal{C}|$ symbols in the codebook $\mathcal{C} = \{x^{LM}(j)\}$ are drawn i.i.d. from a distribution P_X . In this ensemble, the codewords do not have fixed composition with probability 1 and so the standard MMI is not universal (see the discussion after the proof of Prop. 17 in the next subsection for the reason to preferring this ensemble of the fixed composition ensemble). Nonetheless, for this ensemble, the random coding exponent of the ML rule can be achieved by a variant of the MMI, which includes an additional penalty term.

In this section, we first briefly describe the standard MMI rule and then adapt it to DNA channel. We then modify the basic MMI with two penalty terms: One is related to the use of the i.i.d. ensemble (instead of the constant composition ensemble), and the other – to the sampling mechanism of the DNA channel.

Specifically, let \mathcal{A}, \mathcal{B} be finite input and output alphabets (respectively), and let $V: \mathcal{A} \rightarrow \mathcal{B}$ be a DMC. Then, the normalized log-likelihood of an output sequence $b^K \in \mathcal{B}^K$, conditioned on an input sequence $a^K \in \mathcal{A}^K$, is

$$\frac{1}{K} \log V^K(b^K | a^K) = -H_{\mathcal{P}(a^K, b^K)}(B | A) - D(\mathcal{P}(a^K, b^K) || \mathcal{P}(a^K) \times V), \quad (\text{A.30})$$

where $\mathcal{P}(a^K, b^K)$ is the empirical joint distribution of $(a^K, b^K) \in \mathcal{A}^K \times \mathcal{B}^K$. For a codebook $\mathcal{C} \subseteq \mathcal{A}^K$, and given an output vector $b^K \in \mathcal{B}^K$, the ML decoding rule is then

$$\arg \max_{a^K \in \mathcal{C}} \frac{1}{K} \log V^K(b^K | a^K) = \arg \min_{a^K \in \mathcal{C}} [H_{\mathcal{P}(a^K, b^K)}(B | A) + D(\mathcal{P}(a^K, b^K) || \mathcal{P}(a^K) \times V)]. \quad (\text{A.31})$$

In universal decoding for DMCs, the decoding metric does not depend on the channel V . A possible decoding rule replaces the normalized log-likelihood with its maximized version over all DMCs from $\mathcal{A} \rightarrow \mathcal{B}$. The resulting decoding rule is then

$$\arg \max_{a^K \in \mathcal{C}} \max_V \frac{1}{K} \log V^K(b^K | a^K) = \arg \max_{a^K \in \mathcal{C}} H_{\mathcal{P}(a^K, b^K)}(B | A). \quad (\text{A.32})$$

Equivalently, since $H_{\mathcal{P}(b^K)}(B)$ only depends on the output sequence, and thus is common to all codewords, the decoder chooses the codeword which maximizes the empirical mutual information $I_{\mathcal{P}(a^K, b^K)}(A; B)$. This decoder is called MMI, and evidently it does not depend on the channel V .

When condition on u^N , the likelihood function of the DNA channel (A.27) corresponds to a mixture of binomial channels. The MMI can be generalized, in a straightforward manner, to the mixture of binomial channels as follows. Formally, consider a mixture of binomial channels, parameterized by $(V, K, \{\mathcal{K}_d\}_{d \in [K+1]})$

(where \mathcal{K}_d is a partition of $[K]$). Given a codebook $\mathcal{C} \subseteq \mathcal{A}^K$, an MMI decoder for this channel can be defined as

$$\arg \max_{a^K \in \mathcal{C}} \sum_{d \in \mathbb{N}} \frac{K_d}{K} \cdot I_{\mathcal{P}(a_{\mathcal{K}_d}, b_{\mathcal{K}_d}^d)}(A; B^d), \quad (\text{A.33})$$

which amounts to averaging of the empirical mutual information over the possible orders d , while taking into account their proportion in the K symbols.

Equipped with these preliminaries, we next develop a universal decoder for the DNA channel $\text{DNA} = \{\alpha, \beta, W\}$. As said, the maximum-likelihood rule $\arg \max_{j \in [|\mathcal{C}|]} \mathcal{L}[y^{LN} | x^{LM}(j)]$ is the optimal decoder. Here, the main motivation for using the universal decoder is mostly in order to facilitate the analysis (with the additional benefit that the knowledge of the sequencing channel W is not required). It is evident from (A.28) that the likelihood is a mixture (over u^N) of a mixture (over d) of binomial channels. Had u^N been known to the decoder, a possible universal decoder is the MMI for the mixture of binomial channels stated in (A.33), which in the DNA channel amounts to the metric

$$\log \mathcal{L}(y^{LN} | x^{LM}; u^N) = \sum_{d \in [K+1]} q_d L \cdot I_{\hat{P}^d(x^{LM}, y^{LN}; u^N)}(A; B^d) \quad (\text{A.34})$$

where $q^{N+1} = \mathcal{N}^{(2)}(u^N)$. For the DNA channel, u^N is unknown, and so we propose to further maximize this metric over $u^N \in \mathcal{F}_{q^{N+1}}^{(2)}$, albeit with a penalty term related to $|\mathcal{F}_{q^{N+1}}^{(2)}|$. From a technical perspective, this penalty will compensate for a standard union bound that will be used in the random coding analysis, as is common in related scenarios (e.g., universal decoding for joint source-channel coding [9]). Intuitively, this penalty will favor less the likelihood of $\{u^N\}$ which belong to a large amplification type class $\mathcal{F}_{q^{N+1}}^{(2)}$. More precisely, the proposed penalty is the first order term in the asymptotic expansion of the logarithm of the size of $|\mathcal{F}_{q^{N+1}}^{(2)}|$, rather than its exact size, which according to Prop. 15, is

$$\log |\mathcal{F}_{q^{N+1}}^{(2)}| = (M - q_0) \log M + O(M). \quad (\text{A.35})$$

Moreover, the maximization will not be over all possible $\{u^N\}$. Instead, a finite \bar{d} is set, and only u^N for which $q^{N+1} = \mathcal{N}^{(2)}(u^N) \in \mathcal{Q}_{\bar{d}}(M, N)$ are feasible in the maximization, where

$$\mathcal{Q}_{\bar{d}}(M, N) := \{q^{N+1} \in \mathcal{Q}(M, N): q_d = 0 \forall d \geq \bar{d}\}. \quad (\text{A.36})$$

That is, the set of candidate $\{q^{N+1}\}$ does not include a single molecule being sampled more than \bar{d} times. This restriction will be instrumental for the analysis.

In addition to the penalty term $\log |\mathcal{F}_{q^{N+1}}^{(2)}|$, we add another penalty term related to the choice of i.i.d. ensemble, instead of the fixed composition ensemble. To this end, let $\hat{P}^d(x^{LM}; u^N)$ be the x -marginal of $\hat{P}^d(x^{LM}, y^{LN}; u^N)$. Assuming an input distribution P_X , this penalty term for the d order binomial channel, is

the normalized asymptotic expansion of the probability that the input to the d order binomial channel has type $\hat{P}^d(x^{LM}; u^N)$, which is given by $D(\hat{P}^d(x^{LM}; u^N) \parallel P_X)$.

The result is that the universal decoder replaces log-likelihood $\log \mathcal{L}[y^{LN} \mid x^{LM}(j)]$ with the following universal metric:

$$\log \mathcal{L}_u[y^{LN} \mid x^{LM}(j)] = \max_{q^{N+1} \in \mathcal{Q}_{\bar{d}}(M, N)} \max_{s \in \mathcal{T}_{q^{N+1}}} \max_{u \in \mathcal{T}_{s^M}} \lambda(y^{LN} \mid x^{LM}(j); q^{N+1}, s^M, u^N), \quad (\text{A.37})$$

with $\lambda(y^{LN} \mid x^{LM}; u^N)$ is defined as

$$\lambda(y^{LN} \mid x^{LM}; u^N) := -(M - q_0) \log M + \sum_{d \in [N+1]} q_d L \cdot \left[D(\hat{P}^d(x^{LM}; u^N) \parallel P_X) + I_{\hat{P}^d(x^{LM}, y^{LN}; u^N)}(A; B^d) \right], \quad (\text{A.38})$$

where $q^{N+1} = \mathcal{N}^{(2)}(u^N)$ in (A.38) is assumed. As a final remark, we mention that constructing the decoder on the basis of empirical types on a ‘‘symbol-wise’’ level is only justified here since the sequencing channel W^L is a product of L DMCs $W: \mathcal{X} \rightarrow \mathcal{Y}$.

D. Random-Coding Error Probability Analysis for a Given Q^{N+1}

We now to analyze the random coding error exponent of the proposed universal decoder for the following random ensemble: The $ML \cdot |\mathcal{C}|$ symbols in the codebook $\mathcal{C} = \{x^{LM}(j)\}$ are drawn i.i.d. from a distribution P_X . We evaluate the average error probability conditioned on $Q^{N+1} = q^{N+1}$ and show that that if the rate does not cross a prescribed threshold, then the average error probability decays exponentially in $K_M = ML = \beta M \log M$. The proof for the bounds on the reliability function of Theorems 8 and 9 is concluded in the next subsections by averaging over Q^{N+1} . As mentioned in the previous subsection, we set $\bar{d} \in \mathbb{N}^+$ and only consider $q^{N+1} \in \mathcal{Q}_{\bar{d}}(M, N)$, that is q^{N+1} for which $q_d = 0$ for all $d \geq \bar{d}$.

As we have seen, the likelihood function of the DNA channel is obtained by a mixture of binomial channels. To facilitate the random coding analysis, we first state a general result regarding exponential probability bounds for such channels. Since our statements are for general DMCs, we denote the blocklength by $K \in \mathbb{N}^+$, the input alphabet by \mathcal{A} and the output alphabet by \mathcal{B} in order to avoid confusion with the notation of the DNA channel.

Let $V: \mathcal{A} \rightarrow \mathcal{B}$ be a DMC, and let $V^{\oplus d}: \mathcal{A} \rightarrow \mathcal{B}^d$ be its binomial extension. For a blocklength K , consider a *mixture* of d -order binomial channels $(V, K, \{\mathcal{K}_d\}_{d \in \mathbb{N}^+})$ where $\{\mathcal{K}_d\}_{d \in \mathbb{N}^+}$ is a partition of $[K]$. Let a^K (respectively b^K) be the input (respectively output) to this channel, and assume that $\mathcal{K}_d \subseteq [K]$ are the indices of inputs a_k which are input to $V^{\oplus d}$. We denote $a_{\mathcal{K}_d} = (a_k)_{k \in \mathcal{K}_d}$ according to increasing order in \mathcal{K}_d , and use a similar notation for b^K . Note that \mathcal{K}_d can be the empty set, but these sets will simply be ignored in a natural

way in the next derivations. We thus assume that

$$\mathbb{P} \left[B^{(*K)} = (b^*)^K \mid A^K = a^K \right] = \prod_{d=0}^{\infty} V^{\oplus d} \left[b_{\mathcal{K}_d}^d \mid a_{\mathcal{K}_d} \right] = \prod_{d=0}^{\infty} \prod_{k \in \mathcal{K}_d} V^{\oplus d} \left[b_k^d \mid a_k \right] = \prod_{d=0}^{\infty} \prod_{k \in \mathcal{K}_d} \prod_{i=0}^{d-1} V \left[b_{k,i} \mid a_k \right]. \quad (\text{A.39})$$

Note that in the last expression, $(b^*)^K$ designates an output vector whose components may have different dimensions (according to the order d). The following is a generalization of well known bounds:

Proposition 16. *Let $V: \mathcal{A} \rightarrow \mathcal{B}$ be a DMC and let $V^{\oplus d}$ be its d -order binomial extension. Assume that $A^K \in \mathcal{A}^K$ has i.i.d. components distributed according to P_A . Let $\{\mathcal{K}_d\}_{d \in \mathbb{N}^+}$ be a partition of $[K]$ and $K_d = |\mathcal{K}_d|$. Assume further that $K_d = 0$ for all $d \geq \bar{d}$. Then:*

1) *If $b_{\mathcal{K}_d}$ is fixed and has type $Q_{B^d}^{(d)}$ for $d \in \mathbb{N}^+$, then for any given sequence of joint type $Q_{AB^d}^{(d)}$ (whose B -marginals all agree with $Q_B^{(d)}$)*

$$\mathbb{P} \left[\bigcap_{d \in [\bar{d}]} (A_{\mathcal{K}_d}, b_{\mathcal{K}_d}^d) \in \mathcal{T}_{K_d}(Q_{AB^d}^{(d)}) \right] \leq \exp \left\{ -K \cdot \left[\sum_{d \in [K]} \frac{K_d}{K} \cdot \left(D(Q_A \parallel P_A) + I_{Q^{(d)}}(A; B^d) + O\left(\frac{|\mathcal{A}||\mathcal{B}|^d \log K_d}{K_d}\right) \right) \right] \right\}. \quad (\text{A.40})$$

2) *If $B_k \sim V^{\oplus d}(\cdot | A_k)$ independently for all $k \in \mathcal{K}_d$ and all $d \in [K]$, that is $\mathbb{P}[B^{*K} = b^{*K} \mid A^K = a^K]$ is as in (A.39), then*

$$\mathbb{P} \left[\bigcap_{d \in [\bar{d}]} (A_{\mathcal{K}_d}, B_{\mathcal{K}_d}^d) \in \mathcal{T}_{K_d}^{(d)}(Q_{AB^d}^{(d)}) \right] \leq \exp \left\{ -K \cdot \left[\sum_{d \in [K]} \frac{K_d}{K} \cdot \left(D(Q_A^{(d)} \parallel P_A) + D(Q_{B|A}^{(d)} \parallel V^{\oplus d} | Q_A) + O\left(\frac{|\mathcal{A}||\mathcal{B}|^d \log K_d}{K_d}\right) \right) \right] \right\}. \quad (\text{A.41})$$

Proof: First assume that $K_d = K$ for some d . The proof then extends in a straightforward manner the same results obtained by the standard *method of types* [10], [11]. Specifically, by arguments as in [11, Problem 2.3] for (A.40), and [11, Lemma 2.6] for (A.41). The second-order term $O(|\mathcal{A}||\mathcal{B}|^d \cdot (\log K)/K)$ follows from the standard estimate [11, Lemma 2.2] on the number of joint types for $V^{\oplus d}: \mathcal{A} \rightarrow \mathcal{B}^d$

$$|\mathcal{P}_K(\mathcal{A} \times \mathcal{B}^d)| \leq (K+1)^{|\mathcal{A}||\mathcal{B}|^d} = \exp \left[|\mathcal{A}||\mathcal{B}|^d \cdot \log(K+1) \right]. \quad (\text{A.42})$$

The bound for a general partition $\{\mathcal{K}_d\}$ then follows from the statistical independence of the inputs to the various order- d binomial channels. ■

We emphasize that since $K_d = 0$ for all $d \geq \bar{d}$, the second-order term in A.40 and (A.41) is *uniformly* bounded as $O(|\mathcal{A}||\mathcal{B}|^{\bar{d}} \cdot (\log K)/K)$. As common, A.40 will be used to analyze the probability that a competing codeword has larger decoding metric than the true codeword (for a given output), and (A.41) will be used to

analyze the probability of observing a codeword and its output under the random coding assumption and the channel's randomness. We now have the following random coding bound conditioned on $Q^{N+1} = q^{N+1}$:

Proposition 17. *Consider the DNA channel $\text{DNA} = (\alpha, \beta, W)$. Let $q^{N+1} \in \mathcal{Q}(M, N)$ be given. Suppose that the codebook \mathcal{C} is drawn with i.i.d. symbols and codewords from $P_X \in \mathcal{P}(\mathcal{X})$. Let the universal decoder \mathcal{D}_u be such that $y^{LN} \in \mathcal{D}_u(j)$ if*

$$j \in \arg \max_{\tilde{j} \in \|\mathcal{C}\|} \log \mathcal{L}_u(y^{LN} | x^{LM}(\tilde{j})). \quad (\text{A.43})$$

Then,

$$\mathbb{E}_{\mathcal{C}} [\text{pe}(\mathcal{C}, \mathcal{D}_u | x^{LM}(1) \text{ stored}, Q^{N+1} = q^{N+1})] \leq \exp \left[-ML \cdot \left(E_{\bar{d}}(R, \text{DNA} | q^{N+1}) - O_{\bar{d}} \left(\frac{1}{\sqrt{M} \log M} \right) \right) \right] \quad (\text{A.44})$$

where $\mathbb{E}_{\mathcal{C}}[\cdot]$ denotes expectation over the random codebook, $\text{pe}(\mathcal{C}, \mathcal{D}_u | x^{LM}(j), q^{N+1})$ is a conditional version of the error probability (9) and

$$E_{\bar{d}}(R, \text{DNA} | q^{N+1}) := \min_{\{Q_{AB^d}^{(d)}\}_{d \in [\bar{d}+1]}} \sum_{d \in [\bar{d}+1]} \frac{q_d}{M} \cdot \left(D(Q_A^{(d)} \| P_X) + D(Q_{B^d|A}^{(d)} \| V^{\oplus d} | Q_A) \right) + \left[\sum_{d \in [\bar{d}+1]} \frac{q_d}{M} \cdot \left(D(Q_A^{(d)} \| P_X) + I_{Q^{(d)}}(A; B^d) \right) - \frac{1}{\beta} \left(1 - \frac{q_0}{M} \right) - R \right]_+. \quad (\text{A.45})$$

Proof: Since all $s^M \in \mathcal{T}_{q^{N+1}}$ are equiprobable, and all $u^N \in \mathcal{T}_{q^{N+1}}^{(2)}$ are equiprobable too, symmetry implies that we can condition on an arbitrary $s^M \in \mathcal{T}_{q^{N+1}}$ as well as an arbitrary $u^N \in \mathcal{T}_{s^M} = \mathcal{T}_{q^{N+1}}^{(2)}$. We bound the average conditional error probability in the following standard way, which comprises two steps. First, we condition on the randomly chosen stored codeword, $x^{LM}(1)$, and the corresponding channel output, y^{LN} , and compute the probability that a single random codeword has a larger decoding metric than $\mathcal{L}_u(y^{LN} | x^{LM}(1))$, and then we take a clipped union bound over $e^{MLR} - 1$ competing codewords. Second, we compute the average over $x^{LM}(1), y^{LN}$, connected via the DNA channel.

We begin with the first step. Assume that $x^{LM}(1) \equiv x^{LM}$ was stored and y^{LN} was the output, and consider a competing random codeword $x^{LM}(j) \equiv \tilde{X}^{LM}$ for some $j \in \|\mathcal{C}\| \setminus \{1\}$ (whose ML symbols are P_X -i.i.d.). Denote temporarily, for brevity, the event

$$\mathcal{E} := \{X^{LM}(1) = x^{LM}, Y^{LN} = y^{LN}, Q^{N+1} = q^{N+1}, S^M = s^M, U^N = u^N\}. \quad (\text{A.46})$$

The pairwise error probability is bounded as

$$\mathbb{P} \left[\log \mathcal{L}_u(y^{LN} | \tilde{X}^{LM}) \geq \log \mathcal{L}_u(y^{LN} | x^{LM}) \mid \mathcal{E} \right]$$

$$\stackrel{(a)}{\leq} \mathbb{P} \left[\log \mathcal{L}_u(y^{LN} | \tilde{X}^{LM}) \geq \lambda(y^{LN} | x^{LM}; u^N) \mid \mathcal{E} \right] \quad (\text{A.47})$$

$$= \mathbb{P} \left[\max_{\tilde{q}^{N+1} \in \mathcal{Q}_{\bar{d}}(M, N)} \max_{\tilde{u}^N \in \mathcal{T}_{q^{N+1}}^{(2)}} \lambda(y^{LN} | \tilde{X}^{LM}; \tilde{u}^N) \geq \lambda(y^{LN} | x^{LM}; u^N) \mid \mathcal{E} \right] \quad (\text{A.48})$$

$$\stackrel{(b)}{\leq} \sum_{\tilde{q}^{N+1} \in \mathcal{Q}_{\bar{d}}(M, N)} \sum_{\tilde{u}^N \in \mathcal{T}_{q^{N+1}}^{(2)}} \mathbb{P} \left[\lambda(y^{LN} | \tilde{X}^{LM}; \tilde{u}^N) \geq \lambda(y^{LN} | x^{LM}; u^N) \mid \mathcal{E} \right] \quad (\text{A.49})$$

$$\stackrel{(c)}{\leq} e^{O(\sqrt{M})} N^{M-\tilde{q}_0} \max_{\tilde{q}^{N+1} \in \mathcal{Q}_{\bar{d}}(M, N)} \max_{\tilde{u} \in \mathcal{T}_{q^{N+1}}^{(2)}} \cdot \mathbb{P} \left[\lambda(y^{LN} | \tilde{X}^{LM}; \tilde{u}^N) \geq \lambda(y^{LN} | x^{LM}; u^N) \mid \mathcal{E} \right], \quad (\text{A.50})$$

where (a) follows since from the definition of the universal metric $\log \mathcal{L}_u(y^{LN} | x^{LM})$ in (A.37)

$$\log \mathcal{L}_u(y^{LN} | x^{LM}) \geq \lambda(y^{LN} | x^{LM}; u^N) \quad (\text{A.51})$$

[using the possibly sub-optimal choice u^N in (A.37)], (b) follows from the union bound, and (c) follows from Prop. 15. We next evaluate the inner probability for a specific choice of \tilde{u}^N . The value of $\lambda(y^{LN} | \tilde{x}^{LM}; \tilde{u}^N)$ is equivalently determined by $(\tilde{A}_{\mathcal{K}_d}, b_{\mathcal{K}_d}^d)_{d \in [\bar{d}+1]}$ corresponding to $(\tilde{u}^N, \tilde{x}^{LM}, y^{LN})$, where the symbols $\tilde{A}^K \in \mathcal{A}^K$ are drawn i.i.d. according to P_X . Letting $\{\tilde{Q}_{AB^d}^{(d)}\}_{d \in [\bar{d}+1]}$ be a collection of types with $\tilde{Q}_{B^d}^{(d)} = Q_{B^d}^{(d)} = \mathcal{P}(b_{\mathcal{K}_d}^d)$, Prop. 16 states that

$$\begin{aligned} & \mathbb{P} \left[\bigcap_{d \in [\bar{d}+1]: q_d \neq 0} (\tilde{A}_{\mathcal{K}_d}, b_{\mathcal{K}_d}^d) \in \mathcal{T}_{K_d}(\tilde{Q}_{AB^d}^{(d)}) \right] \\ & \leq \exp \left\{ -ML \cdot \left[\sum_{d \in [\bar{d}+1]: q_d \neq 0} \frac{q_d}{M} \cdot \left(D(\tilde{Q}_A^{(d)} \| P_X) + I_{\tilde{Q}^{(d)}}(A; B^d) + O\left(\frac{|\mathcal{X}||\mathcal{Y}|^d \log Lq_d}{Lq_d}\right) \right) \right] \right\} \quad (\text{A.52}) \end{aligned}$$

$$\leq \exp \left\{ -ML \cdot \left[\sum_{d \in [\bar{d}+1]: q_d \neq 0} \frac{q_d}{M} \cdot \left(D(\tilde{Q}_A^{(d)} \| P_X) + I_{\tilde{Q}^{(d)}}(A; B^d) \right) + O_{\bar{d}}\left(\frac{\log(ML)}{ML}\right) \right] \right\} \quad (\text{A.53})$$

where the last inequality follows from

$$\sum_{d \in [\bar{d}+1]} \frac{q_d}{M} \cdot \frac{|\mathcal{X}||\mathcal{Y}|^d \log(Lq_d)}{Lq_d} = \frac{1}{ML} \sum_{d \in [\bar{d}+1]} |\mathcal{X}||\mathcal{Y}|^d \log(Lq_d) \leq \bar{d} |\mathcal{X}||\mathcal{Y}|^{\bar{d}} \frac{\log(ML)}{ML} = O_{\bar{d}}\left(\frac{\log(ML)}{ML}\right). \quad (\text{A.54})$$

Next, we note that $\lambda(y^{LN} | \tilde{x}^{LM}; \tilde{u}^N)$ is determined by the empirical types of $\mathcal{P}(\tilde{A}_{\mathcal{K}_d}, b_{\mathcal{K}_d}^d) = \hat{P}^d(\tilde{x}^{LM}, y^{LN}; \tilde{u}^N)$, for $d \in [\bar{d}+1]$. The number of possible types of $(\tilde{A}_{\mathcal{K}_d}, b_{\mathcal{K}_d}^d)$ is less than $(K_d + 1)^{|\mathcal{X}||\mathcal{Y}|^d} = (q_d L + 1)^{|\mathcal{X}||\mathcal{Y}|^d} = \exp[|\mathcal{X}||\mathcal{Y}|^d \cdot \log(q_d L + 1)]$ [as in (A.42)]. Consequently, the number of possible sets of types $\{\tilde{Q}_{AB^d}^{(d)}\}_{d \in [\bar{d}+1]}$ is upper bounded by

$$\prod_{d=0}^{\bar{d}} \exp \left[|\mathcal{X}||\mathcal{Y}|^d \cdot \log(q_d L + 1) \right] \leq \exp \left[\bar{d} |\mathcal{X}||\mathcal{Y}|^{\bar{d}} \cdot \log(ML + 1) \right] \quad (\text{A.55})$$

which is polynomial in $K = ML$ (for fixed \bar{d}). By the union bound over those set of types

$$\begin{aligned} & \mathbb{P} \left[\lambda(y^{LN} | \tilde{X}^{LM}; \tilde{u}^N) \geq \lambda(y^{LN} | x^{LM}; u^N) | \mathcal{E} \right] \\ & \leq \sum_{\{\tilde{Q}_{AB^d}^{(d)}\}_{d \in [\bar{d}+1]}} \mathbb{P} \left[\bigcap_{d=0}^{\bar{d}} (\tilde{A}_{\mathcal{K}_d}, b_{\mathcal{K}_d}^d) \in \mathcal{T}_{K_d}^{(d)}(\tilde{Q}_{AB^d}^{(d)}) \right] \end{aligned} \quad (\text{A.56})$$

where the sum is over $\{\tilde{Q}_{AB^d}^{(d)}\}_{d \in [\bar{d}+1]}$ such that $\tilde{Q}_{B^d}^{(d)} = Q_{B^d}^{(d)}$ and

$$\begin{aligned} & -(M - \tilde{q}_0) \log N + \sum_{d \in [\bar{d}+1]} \tilde{q}_d L \cdot \left(D(\tilde{Q}_A^{(d)} || P_X) + I_{\tilde{Q}_{AB}^{(d)}}(A; B^d) \right) \\ & \geq \lambda(y^{LN} | x^{LM}; u^N) \\ & = -(M - q_0) \log N + \sum_{d \in [\bar{d}+1]} q_d L \cdot \left(D(\hat{P}^d(x^{LM}; u^N) || P_X) + I_{\hat{P}^d(x^{LM}, y^{LN}; u^N)}(A; B^d) \right) \end{aligned} \quad (\text{A.57})$$

holds. By (A.53), (A.55), the last display, we obtain that

$$\begin{aligned} & \mathbb{P} \left[\lambda(y^{LN} | \tilde{X}^{LM}; \tilde{u}^N) \geq \lambda(y^{LN} | x^{LM}; u^N) | \mathcal{E} \right] \\ & \leq e^{O(\log(ML))} \cdot \exp \left[-(M - \tilde{q}_0) \log N + (M - q_0) \log N \right] \\ & \quad \times \exp \left\{ -ML \cdot \left[\sum_{d \in [\bar{d}+1]} \frac{q_d}{M} \left(D(\hat{P}^d(x^{LM}; u^N) || P_X) + I_{\hat{P}^d(x^{LM}, y^{LN}; u^N)}(A; B^d) \right) + O_{\bar{d}} \left(\frac{\log(ML)}{ML} \right) \right] \right\}. \end{aligned} \quad (\text{A.58})$$

Inserting this bound into (A.50), we then obtain

$$\begin{aligned} & \log \mathbb{P} \left[\mathcal{L}_u(y^{LN} | \tilde{X}^{LM}) \geq \mathcal{L}_u(y^{LN} | x^{LM}) | \mathcal{E} \right] \\ & \leq O(\sqrt{M}) + (M - q_0) \log N \\ & \quad - ML \cdot \left[\sum_{d \in [\bar{d}+1]} \frac{q_d}{M} \cdot \left(D(\hat{P}^d(x^{LM}; u^N) || P_X) + I_{\hat{P}^d(x^{LM}, y^{LN}; u^N)}(A; B^d) \right) + O_{\bar{d}} \left(\frac{\log(ML)}{ML} \right) \right] \quad (\text{A.59}) \\ & = -ML \cdot \left[\sum_{d \in [\bar{d}+1]} \frac{q_d}{M} \cdot \left(D(\hat{P}^d(x^{LM}; u^N) || P_X) + I_{\hat{P}^d(x^{LM}, y^{LN}; u^N)}(A; B^d) \right) - \frac{1}{\beta} \left(1 - \frac{q_0}{M} \right) + O \left(\frac{1}{\sqrt{ML}} \right) \right] \end{aligned} \quad (\text{A.60})$$

where in (a) we have used that $\alpha = \frac{N}{M}$ is constant²¹ and $\beta = \frac{L}{\log M}$. This completes the bound on the pairwise error probability for a single competing codeword. Letting now $\overline{\text{pe}}(\mathcal{C}, \mathcal{D}_u | \mathcal{E})$ be the conditional average error probability over all $e^{MLR} - 1$ competing codewords, the clipped union bound implies

$$- \frac{1}{ML} \log \mathbb{E}_{\mathcal{C}} [\overline{\text{pe}}(\mathcal{C}, \mathcal{D}_u | \mathcal{E})] \geq$$

²¹In fact, $\alpha = o(\log M)$ suffices.

$$\left[\sum_{d \in [\bar{d}+1]} \frac{q_d}{M} \cdot \left(D(\hat{P}^d(x^{LM}; u^N) \| P_X) + I_{\hat{P}^d(x^{LM}, y^{LN}; u^N)}(A; B^d) \right) - \frac{1}{\beta} \left(1 - \frac{q_0}{M} \right) - R \right]_+ - O\left(\frac{1}{\sqrt{ML}}\right). \quad (\text{A.61})$$

This completes the first step of the proof.

We now move on to the second step in which we average over $(X^{LM} \equiv X^{LM}(1), Y^{LN})$. In the first step, we have seen that the pairwise error probability conditioned on $(X^{LM}, Y^{LN}) = (x^{LM}, y^{LN})$ depends on $\sum_{d \in [\bar{d}+1]} \frac{q_d}{M} \cdot D(\hat{P}^d(x^{LM}; u^N) \| P_X) + \sum_{d \in [\bar{d}+1]} \frac{q_d}{M} I_{\hat{P}^d(x^{LM}, y^{LN}; u^N)}(A; B^d)$, which in turn depend on the types $\{\hat{P}^d(x^{LM}, y^{LN}; u^N)\}_{d \in [\bar{d}+1]}$. We next evaluate the probability distribution of this term, conditioned on the given q^{N+1} , and the arbitrary representative $u^N \in \mathcal{T}_{q^{N+1}}^{(2)}$. As in the first step, we denote $\hat{P}^d(x^{LM}, y^{LN}; u^N) = Q_{AB^d}^{(d)}$. Prop. 16 states that in case the random output $B_{\mathcal{K}_d}^d$ is the result of $A_{\mathcal{K}_d}$ passing in the channel $V^{\oplus d}$, it holds that

$$\begin{aligned} & \mathbb{P} \left[\bigcap_{d \in [\bar{d}+1]: q_d \neq 0} (A_{\mathcal{K}_d}, B_{\mathcal{K}_d}) \in \mathcal{T}_{\mathcal{K}_d}(Q_{AB^d}^{(d)}) \right] \\ & \leq \exp \left\{ -ML \cdot \left[\sum_{d \in [\bar{d}+1]: q_d \neq 0} \frac{q_d}{M} \cdot \left(D(Q_A^{(d)} \| P_X) + D(Q_{B^d|A}^{(d)} \| V^{\oplus d} | Q_A) \right) + O_{\bar{d}} \left(\frac{\log(ML)}{ML} \right) \right] \right\}, \end{aligned} \quad (\text{A.62})$$

where the second-order term is bounded as in (A.54). Thus, for $s^M \in \mathcal{T}_{q^{N+1}}$ and $u^N \in \mathcal{T}_{s^M}$

$$\begin{aligned} & \mathbb{E}_{\mathcal{C}} [\text{pe}(\mathcal{C}, \mathcal{D}_u | x^{LM}(1) \text{ stored}, Q^{N+1} = q^{N+1})] \\ & = \mathbb{E}_{\mathcal{C}} [\text{pe}(\mathcal{C}, \mathcal{D}_u | Q^{N+1} = q^{N+1}, S^M = s^M, U^N = u^N)] \end{aligned} \quad (\text{A.63})$$

$$= \sum_{\{Q_{AB^d}^{(d)}\}_{d \in [\bar{d}]}} \mathbb{P} \left[\bigcap_{d=0}^{\bar{d}} (A_{\mathcal{K}_d}, B_{\mathcal{K}_d}^d) \in \mathcal{T}_{\mathcal{K}_d}(Q_{AB^d}^{(d)}) \right] \cdot \bar{\text{pe}}(\mathcal{C}, \mathcal{D}_u | \mathcal{E}). \quad (\text{A.64})$$

By (A.61), (A.62) and the bound (A.55) on the total number of sets of types $\{Q_{AB^d}^{(d)}\}_{d \in [\bar{d}+1]}$ (which from (A.55) is polynomial in ML) we obtain that

$$\begin{aligned} & -\frac{1}{ML} \log \mathbb{E}_{\mathcal{C}} [\text{pe}(\mathcal{C}, \mathcal{D} | X^{LM}(1) \text{ stored}, Q^{N+1} = q^{N+1})] \\ & \geq \min_{\{Q_{AB^d}^{(d)}\}} \sum_{d \in [\bar{d}+1]} \frac{q_d}{M} \cdot \left(D(Q_A^{(d)} \| P_X) + D(Q_{B^d|A}^{(d)} \| V^{\oplus d} | Q_A^{(d)}) \right) \\ & \quad + \left[\sum_{d \in [\bar{d}+1]} \frac{q_d}{M} \cdot \left(D(Q_A^{(d)} \| P_X) + I_{Q_{AB^d}^{(d)}}(A; B^d) \right) - \frac{1}{\beta} \left(1 - \frac{q_0}{M} \right) - R \right]_+ - O_{\bar{d}} \left(\frac{1}{\sqrt{M} \log M} \right) \end{aligned} \quad (\text{A.65})$$

$$= E_{\bar{d}}(R, \text{DNA} | q^{N+1}) - O_{\bar{d}} \left(\frac{1}{\sqrt{M} \log M} \right) \quad (\text{A.66})$$

This completes the second step, and the bound on the error probability of the first codeword. \blacksquare

We pause for a few remarks:

- 1) The second-order term $O_{\bar{d}}(1/\sqrt{M} \log M)$ depends only on $(\bar{d}, \mathcal{X}, \mathcal{Y})$ and thus is uniform in q^{N+1} .
- 2) Furthermore, the q^{N+1} being conditioned upon is not restricted to $\mathcal{Q}_{\bar{d}}(M, N)$ but can have non-zero q_d for $d > \bar{d}$. Nonetheless, the universal decoder ignores the molecules which are sampled more than \bar{d} times in its metric computation, and in accordance, only q_d for $d \in [\bar{d} + 1]$ affect the error probability. The average error probability is then determined by a finite number of types, say $\{\hat{P}^d(x^{LM}, y^{LN}; u^N)\}_{d \in [\bar{d} + 1]}$ for the true and competing codeword, and the total number of types is uniformly bounded for all M (see (A.55)). This is crucial to the proof as if \bar{d} is not restricted, and can be as large as $\Theta(N) = \Theta(M)$ the number of types increases *super-exponentially* with M (rather than the standard *polynomial* increase).
- 3) The random coding ensemble is based on i.i.d. draws of symbols, which can be compared with the simpler (and possibly better) constant composition distribution over a type $\mathcal{T}_{ML}(P_X)$. However, the random sampling stage complicates the analysis of the latter. If codewords are chosen to have a constant composition over all ML symbols, there is no guarantee that the specific inputs to the d -order binomial channel will be of constant composition. If the codewords are chosen to have a constant composition at each of the M molecules, than a random input to the d -order binomial channel is not distributed uniformly over the type class of P_X . Indeed, if, for example, $q_d = 2$, that is, there are 2 molecules which are input to the d -order binomial channel, a random codeword drawn this way will have constant composition P_X at both its parts, and not just as a whole.

E. Proof of Theorem 8

To prove Theorem 8, we need to average the conditional error probability derived in the previous section (given $Q^{N+1} = q^{N+1}$) over the random sampling stage of the decoder. To this end, we will need the following two lemmas. The first lemma shows that the exponent of the probability that Q^{N+1} belongs to some set \mathcal{Q} is determined by the largest probability of members in this set.

Lemma 18. For any $\mathcal{Q} \subseteq \mathcal{Q}(M, N)$

$$\mathbb{P}[Q^{N+1} \notin \mathcal{Q}] = \exp \left[-M \cdot \left(\min_{q^{N+1} \notin \mathcal{Q}} -\frac{1}{M} \log \mathbb{P}[Q^{N+1} = q^{N+1}] \right) + O(\sqrt{M}) \right]. \quad (\text{A.67})$$

Proof: By Prop. 15, $|\mathcal{Q}| \leq e^{O(\sqrt{M})}$ and so by the union bound

$$\max_{q^{N+1} \notin \mathcal{Q}} \mathbb{P}[Q^{N+1} = q^{N+1}] \leq \mathbb{P}[Q^{N+1} \notin \mathcal{Q}] \quad (\text{A.68})$$

$$= \sum_{q^{N+1} \notin \mathcal{Q}} \mathbb{P}[Q^{N+1} = q^{N+1}] \leq |\mathcal{Q}| \cdot \max_{q^{N+1} \notin \mathcal{Q}} \mathbb{P}[Q^{N+1} = q^{N+1}]. \quad (\text{A.69})$$

■

We remark that if $\mathcal{Q} \subseteq \mathcal{Q}_{\bar{d}}(M, N)$ (as we will use next) then since $|\mathcal{Q}_{\bar{d}}(M, N)| \leq M^{\bar{d}}$ [see (A.36)], the second-order term is actually $\bar{d} \log M$ rather than $O(\sqrt{M})$. This is however, inconsequential to our analysis,

and the bound of Lemma 18 nonetheless holds even when \bar{d} is not restricted.

We next turn to evaluate $\frac{1}{M} \log \mathbb{P}[Q^{N+1} = q^{N+1}]$ required for the bound of Lemma 18. The main complication is that $Q^{N+1} = \mathcal{N}(S^M)$ is the empirical count of S^M , but S^M is distributed according to the multinomial distribution, and so its components are statistically dependent. We next use the ‘‘Poissonization of the multinomial’’ effect to evaluate this bound. Recall that $S^M \sim \text{Multinomial}(N; (\frac{1}{M}, \frac{1}{M}, \dots, \frac{1}{M}))$ where $N = M\alpha$ is fixed, and the following fact:

Fact 19 (Poissonization of the multinomial distribution). *Let $\tilde{N} \sim \text{Pois}(\lambda)$, and let \tilde{S}^M be a random vector such that $\tilde{S}^M \sim \text{Multinomial}(\tilde{N}, (p_0, \dots, p_{M-1}))$ conditioned on \tilde{N} , where $\sum_{m \in [M]} p_m = 1$ and $p_m > 0$. Then, $\{\tilde{S}_m\}_{m \in [M]}$ are statistically independent and $\tilde{S}_m \sim \text{Pois}(p_m \lambda)$ (unconditioned on \tilde{N}).*

Fact 19 can be verified by spelling out the conditional p.m.f. of \tilde{S}^M conditioned on \tilde{N} (e.g., [33, Thm. 5.6]).

Lemma 20. *Let $S^M \sim \text{Multinomial}(N, (\frac{1}{M}, \dots, \frac{1}{M}))$ with $N = \alpha M$ and let $Q^{N+1} = \mathcal{N}(S^M)$. Further let $\tilde{S}_m \sim \text{Pois}(\frac{N}{M}) = \text{Pois}(\alpha)$, i.i.d. for $m \in [M]$, and let $\tilde{Q}^{N+1} = \mathcal{N}(\tilde{S}^M)$. Then,*

$$\mathbb{P}[Q^{N+1} = q^{N+1}] \leq \sqrt{e^2 \alpha M} \cdot \mathbb{P}[\tilde{Q}^{N+1} = q^{N+1}]. \quad (\text{A.70})$$

Proof of Lemma 20: Let $\tilde{N} = \sum_{m \in [M]} \tilde{S}_m$ so that $\tilde{N} \sim \text{Pois}(N) = \text{Pois}(\alpha M)$. By Stirling’s bound $n! \leq e \cdot n^{n+1/2} e^{-n}$, and so

$$\mathbb{P}[\tilde{N} = N] = \frac{N^N e^{-N}}{N!} \geq \frac{1}{e\sqrt{N}}. \quad (\text{A.71})$$

Then, by Poissonization (Fact 19)

$$\mathbb{P}[Q^{N+1} = q^{N+1}] = \mathbb{P}[\tilde{Q}^{N+1} = q^{N+1} \mid \tilde{N} = N] \quad (\text{A.72})$$

$$= \frac{\mathbb{P}[\tilde{Q}^{N+1} = q^{N+1}, \tilde{N} = N]}{\mathbb{P}[\tilde{N} = N]} \quad (\text{A.73})$$

$$\leq \frac{\mathbb{P}[\tilde{Q}^{N+1} = q^{N+1}]}{\mathbb{P}[\tilde{N} = N]} \quad (\text{A.74})$$

$$\leq e\sqrt{N} \cdot \mathbb{P}[\tilde{Q}^{N+1} = q^{N+1}]. \quad (\text{A.75})$$

This completes the proof of the upper bound. ■

We now prove Theorem 8, which bounds the error probability for the sampling stage of the DNA channel.

Proof of Theorem 8: Let $\theta_d := q_d/M$. We first rewrite the bound of Prop. 17, with a slight abuse of notation obtained by replacing q_d with θ_d , as

$$\mathbb{E}_{\mathcal{C}} [\text{pe}(\mathcal{C}, \mathcal{D}_u \mid X^{LM}(1) \text{ stored}, \theta)] \leq \exp[-ML \cdot (E_{\bar{d}}(R, \text{DNA} \mid \theta) - \tau_M)] \quad (\text{A.76})$$

where $\tau_M = O_{\bar{d}}\left(\frac{1}{\sqrt{M \log M}}\right)$ and

$$E_{\bar{d}}(R, \text{DNA} \mid \theta) := \min_{\{Q^{(d)}\}_{d \in [\bar{d}+1]}} \sum_{d \in [\bar{d}+1]} \theta_d \cdot \left(D(Q_A^{(d)} \parallel P_X) + D(Q_{B^d|A}^{(d)} \parallel V^{\oplus d} | Q_A) \right) + \left[\sum_{d \in [\bar{d}+1]} \theta_d \cdot \left(D(Q_A^{(d)} \parallel P_X) + I_{Q^{(d)}}(A; B^d) \right) - \frac{1}{\beta} (1 - \theta_0) - R \right]_+. \quad (\text{A.77})$$

Let

$$\Gamma_{\bar{d}}(\theta) := \sum_{d \in [\bar{d}+1]} \theta_d \cdot I(P_X, W^{\oplus d}) - \frac{1}{\beta} (1 - \theta_0) \quad (\text{A.78})$$

and let $\rho > 0$ be arbitrary. Since the KL divergence $D(P \parallel Q) > 0$ for all $P \neq Q$ (strictly positive) it can be easily verified that if $\Gamma_{\bar{d}}(\theta) \geq R + \rho$ then $E_{\bar{d}}(R, \text{DNA} \mid \theta) > 0$. Consider the set

$$\Theta_{\bar{d}}(R, \rho) := \left\{ \theta: \theta_d \geq 0, \forall d \in [\bar{d}], \sum_{d \in [\bar{d}+1]} \theta_d \leq 1, \Gamma_{\bar{d}}(\theta) \geq R + \rho \right\} \quad (\text{A.79})$$

which, loosely speaking, is comprised of θ for which the conditional ‘‘capacity’’ $\Gamma_{\bar{d}}(\theta)$ is larger than the rate $R + \rho$. Since $\Theta_{\bar{d}}(R, \rho)$ is compact, and since $E_{\bar{d}}(R, \text{DNA} \mid \theta)$ is a continuous function of θ , it holds that

$$\epsilon(\rho) := \min_{\theta \in \Theta_{\bar{d}}(R, \rho)} E_{\bar{d}}(R, \text{DNA} \mid \theta) > 0. \quad (\text{A.80})$$

Note that since the minimization defining $\epsilon(\rho)$ is over θ , rather than over q^{N+1} , $\epsilon(\rho)$ does not depend on M , and the last inequality is strict. Now, taking M to be sufficiently large so that $\tau_M \leq \epsilon(\rho)/2$ it holds that if $\frac{q^{N+1}}{M} = \theta \in \Theta_{\bar{d}}(\rho)$ then

$$\mathbb{E}_{\mathcal{C}} [\text{pe}(\mathcal{C}, \mathcal{D}_u \mid x^{LM}(1) \text{ stored}, \theta)] = e^{-ML \cdot \epsilon(\rho)/2}. \quad (\text{A.81})$$

Based on this bound, the conditional error probability bound of Prop. 17 can be averaged over Q^{N+1} as follows:

$$\mathbb{E} [\mathbb{E}_{\mathcal{C}} [\text{pe}(\mathcal{C}, \mathcal{D}_u \mid x^{LM}(1) \text{ stored}, Q^{N+1})]] \quad (\text{A.82})$$

$$= \sum_{q^{N+1} \in \mathcal{Q}(M, N): \frac{q^{N+1}}{M} \in \Theta_{\bar{d}}(R, \rho)} \mathbb{P} [Q^{N+1} = q^{N+1}] \cdot \mathbb{E}_{\mathcal{C}} [\text{pe}(\mathcal{C}, \mathcal{D}_u \mid x^{LM}(1) \text{ stored}, Q^{N+1} = q^{N+1})] + \sum_{q^{N+1} \in \mathcal{Q}(M, N): \frac{q^{N+1}}{M} \notin \Theta_{\bar{d}}(R, \rho)} \mathbb{P} [Q^{N+1} = q^{N+1}] \cdot \mathbb{E}_{\mathcal{C}} [\text{pe}(\mathcal{C}, \mathcal{D}_u \mid x^{LM}(1) \text{ stored}, Q^{N+1} = q^{N+1})] \quad (\text{A.83})$$

$$\leq \mathbb{P} \left[\frac{Q^{N+1}}{M} \notin \Theta_{\bar{d}}(R, \rho) \right] + e^{-ML \cdot \epsilon(\rho)/2} \quad (\text{A.84})$$

$$\stackrel{(a)}{=} \exp \left[-M \cdot \left(\min_{\frac{q^{N+1}}{M} \notin \Theta_{\bar{d}}(R, \rho)} -\frac{1}{M} \log \mathbb{P} [Q^{N+1} = q^{N+1}] \right) + O(\sqrt{M}) \right] + e^{-ML \cdot \epsilon(\rho)/2} \quad (\text{A.85})$$

$$\stackrel{(b)}{=} \exp \left[-M \cdot \left(\min_{\frac{q^{N+1}}{M} \notin \Theta_{\bar{d}}(R, \rho)} -\frac{1}{M} \log \mathbb{P} [\tilde{Q}^{N+1} = q^{N+1}] + O_{\alpha} \left(\frac{1}{\sqrt{M}} \right) \right) \right] + e^{-ML \cdot \epsilon(\rho)/2} \quad (\text{A.86})$$

$$\stackrel{(c)}{\leq} 2 \exp \left[-M \cdot \left(\min_{\frac{q^{N+1}}{M} \notin \Theta_{\bar{d}}(R, \rho)} -\frac{1}{M} \log [\tilde{Q}^{N+1} = q^{N+1}] + O_{\alpha} \left(\frac{1}{\sqrt{M}} \right) \right) \right] \quad (\text{A.87})$$

where (a) is using Lemma 18, (b) is using Lemma 20, where $\tilde{Q}^{N+1} = \mathcal{N}(\tilde{S}^M)$ and $\tilde{S}_m \sim \text{Pois}(\alpha)$ are independent, $m \in [M]$, and (c) holds for all $M \geq M_0(\rho)$ for some $M_0(\text{DNA}, \bar{d}, \rho) \in \mathbb{N}^+$.

We next evaluate $\min_{\frac{q^{N+1}}{M} \notin \Theta_{\bar{d}}(R, \rho)} \frac{1}{M} \log \mathbb{P}[\tilde{Q}^{N+1} = q^{N+1}]$. We begin by considering the distribution of a fixed q_d and then the joint distribution of $\{q_d\}_{d \in [\bar{d}]}$. Since \tilde{S}^M has independent components, it holds for any specific $d \in [\bar{d}]$ that $\tilde{Q}_d = \sum_{m \in [M]} \mathbb{1}\{\tilde{S}_m = d\} \sim \text{Binomial}(M, \pi_{\alpha}(d))$ where $\pi_{\alpha}(d) = \frac{\alpha^d e^{-\alpha}}{d!}$ is the Poisson p.m.f.. By large deviations of the Binomial distribution (as in the method of types for Bernoulli vectors [11, Lemma 2.3])

$$\mathbb{P}[Q_d = \theta_d M] = \exp \left\{ -M \cdot \left[d_b(\theta_d \parallel \pi_{\alpha}(d)) - O \left(\frac{\log M}{M} \right) \right] \right\}. \quad (\text{A.88})$$

The joint distribution of $\{Q_d\}_{d \in [\bar{d}+1]}$ is determined by the distribution of Q_d conditioned on $\{Q_0, \dots, Q_{d-1}\}$ for all $d \in [\bar{d}+1]$. For such d , the total number of molecules for which $\tilde{S}_m \leq d-1$ is $\gamma_d := \sum_{i \in [d]} Q_i$. By symmetry, the identity of those γ_d molecules in $[M]$ is immaterial, and so we further condition, w.l.o.g. that these are the last γ_d molecules of \tilde{S}^M , that is $\tilde{S}_{M-\gamma_d}, \dots, \tilde{S}_{M-1}$. Now, the p.m.f. of \tilde{S}_m for $m \in [M - \gamma_d]$ conditioned on this event is

$$\mathbb{P}[\tilde{S}_m = i \mid \tilde{S}_m \geq d] = \frac{\pi_{\alpha}(i)}{\mathbb{P}[\tilde{S}_m \geq d]} \quad (\text{A.89})$$

$$= \frac{\pi_{\alpha}(i)}{1 - \sum_{i' \in [d]} \pi_{\alpha}(i')} \quad (\text{A.90})$$

$$:= \pi_{\alpha \geq d}(i) \quad (\text{A.91})$$

and the \tilde{S}_m are independent, where $\pi_{\alpha \geq d}(i)$ is the Poisson hazard probability [as defined in (11)]. Hence, $\tilde{Q}_d \sim \text{Binomial}(M - \gamma_d, \pi_{\alpha \geq d}(d))$. By large deviations of the Binomial distribution (as in the method of types [11, Lemma 2.3])

$$\begin{aligned} & \mathbb{P}[\tilde{Q}_d = \theta_d M \mid \{\tilde{Q}_i = \theta_i M\}_{i \in [d]}] \\ &= \exp \left\{ -M \left(1 - \frac{\gamma_d}{M} \right) \cdot \left[d_b \left(\frac{\theta_d}{1 - \gamma_d/M} \parallel \pi_{\alpha \geq d}(d) \right) - O \left(\frac{\log M}{M} \right) \right] \right\} \end{aligned} \quad (\text{A.92})$$

$$= \exp \left[-M \left(1 - \sum_{i \in [d]} \theta_i \right) \cdot d_b \left(\frac{\theta_d}{(1 - \sum_{i \in [d]} \theta_i)} \parallel \pi_{\alpha \geq d}(d) \right) - O \left(\frac{\log M}{M} \right) \right]. \quad (\text{A.93})$$

Thus, for $\{\theta_d M\}$ integers

$$-\frac{1}{M} \log \mathbb{P} \left[\bigcap_{d \in [\bar{d}]} \{\tilde{Q}_d = \theta_d M\} \right] = \sum_{d \in [\bar{d}+1]} \left(1 - \sum_{i \in [d]} \theta_i \right) \cdot d_b \left(\frac{\theta_d}{1 - \sum_{i \in [d]} \theta_i} \parallel \pi_{\alpha \geq d}(d) \right) + O \left(\frac{\log M}{M} \right) \quad (\text{A.94})$$

Using this estimate in (A.87) we obtain

$$\begin{aligned} & -\frac{1}{M} \log \mathbb{E}_{\mathcal{C}} [\text{pe}(\mathcal{C}, \mathcal{D}_u | x^{LM}(1))] \\ & \geq \min_{\theta \notin \Theta_{\bar{d}}(R, \rho)} \sum_{d \in [\bar{d}+1]} \left(1 - \sum_{i \in [d]} \theta_i \right) \cdot d_b \left(\frac{\theta_d}{1 - \sum_{i \in [d]} \theta_i} \left\| \pi_{\alpha | \geq d}(d) \right\| \right) + O_{\alpha} \left(\frac{1}{\sqrt{M}} \right). \end{aligned} \quad (\text{A.95})$$

From the linearity of expectation and symmetry,

$$\mathbb{E}_{\mathcal{C}} \left[\frac{1}{|\mathcal{C}|} \sum_{j \in [|\mathcal{C}|]} \text{pe}(\mathcal{C}, \mathcal{D} | X^{LM}(j)) \right] = \mathbb{E}_{\mathcal{C}} [\text{pe}(\mathcal{C}, \mathcal{D} | X^{LM}(1)) \text{ stored}], \quad (\text{A.96})$$

and so the same bounds hold for the average error probability. Finally, we take $\rho \downarrow 0$ and then $\bar{d} \uparrow \infty$. The bound on the average error probability implies a suitable bound to on the maximal error probability by a standard expurgation argument. \blacksquare

F. Proof of Theorem 9

We next prove Theorem 9 which bounds the error probability for idealized version of the sampling stage of the DNA channel.

Proof of Theorem 9: The result is a simple corollary to Prop. 17, obtained by setting $q_d = M \cdot \mathbb{1}[d = \alpha]$ in the conditioning event. For any finite $\bar{d} > \alpha$, the resulting reliability function, w.r.t. scaling ML , is given by

$$E_{\bar{d}}(R, \text{DNA} | q) = \min_{Q_{AB^{\alpha}}} \left(D(Q_A || P_X) + D(Q_{B^{\alpha}|A} || V^{\oplus \alpha} | Q_A) \right) + \left[D(Q_A || P_X) + I_Q(A; B^{\alpha}) - \frac{1}{\beta} - R \right]_{+}. \quad (\text{A.97})$$

For ideal sampling $q_d = M \cdot \mathbb{1}[d = \alpha]$ with probability 1, and so no further averaging is required to obtain the bound on the error probability. \blacksquare

APPENDIX B

PROOF OF THEOREM 10

In this section, we prove Theorem 10. A roadmap for the results required to prove it appears in Fig. 6. Recall the definition of the CID in (21), and define

$$J_d(P_X, W, \beta) := \left(I(P_X, W^{\oplus d}) - \left[\text{CID}(P_X, W^{\oplus d}) - \frac{1}{\beta} \right]_{+} + \left[\text{CID}(P_X, W^{\oplus d}) - \frac{2}{\beta} \right]_{+} \right). \quad (\text{B.1})$$

The main argument of the proof is standard, and given as follows:

Proof of Theorem 10: Assume that \mathcal{C}_M is an (M, ϵ) codebook of size e^{MLR} . Fano's inequality implies that

$$R \leq \frac{1}{ML} + \epsilon + \frac{I(X^{LM}; Y^{LN})}{ML}. \quad (\text{B.2})$$

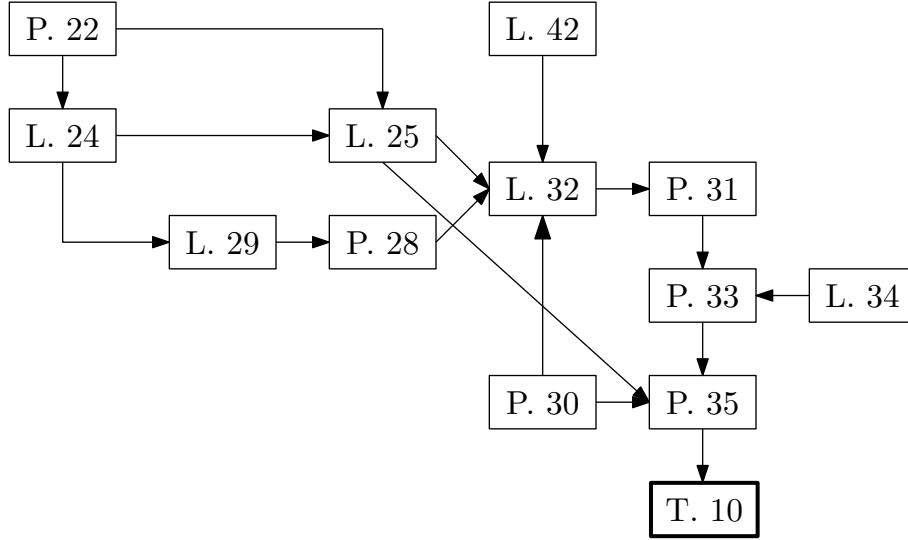

Figure 6. Roadmap for the proofs of the upper bound (converse). The used abbreviations and arrow interpretation are as in Fig. 5. .

The rest of the section is devoted to bounding $I(X^{LM}; Y^{LN})$. Its final result Prop. 34, which states that

$$\frac{1}{ML} I(X^{LM}; Y^{LN}) \leq \max_{P_X} \sum_{d \in \mathbb{N}} \pi_\alpha(d) \cdot J_d(P_X, W, \beta) + o(1). \quad (\text{B.3})$$

Taking $\epsilon \downarrow 0$, and replacing $J_d(P_X, W, \beta)$ with the excess term $\Omega_d(P_X, W, \beta)$ from (22) by simple algebraic manipulations completes the proof of the upper bound on the capacity. ■

A. A Brief Review of Typical Sets

In this short section we set basic definitions of conditional typical sets [11, Ch. 2], and briefly review some standard results. Let $V: \mathcal{A} \rightarrow \mathcal{B}$ be a DMC for the finite alphabets \mathcal{A} and \mathcal{B} , and let $K \in \mathbb{N}^+$ be the blocklength.

For a given $Q_A \in \mathcal{P}_K(\mathcal{A})$ and $\delta > 0$ let

$$[V | Q_A]_\delta := \left\{ V \in \mathcal{P}_K(\mathcal{B} | Q_A): Q_A(a) \cdot \left| \tilde{V}(b | a) - V(b | a) \right| \leq \delta, \forall (a, b) \in \mathcal{A} \times \mathcal{B} \right\} \\ \cap \left\{ \tilde{V}(\cdot | a) \ll V(\cdot | a), \forall a \in \text{supp}(Q_A) \right\} \quad (\text{B.4})$$

be a set of conditional types which are δ -close to V in a total variation sense, uniformly over \mathcal{A} . In what follows whenever Q_A in the definition (B.4) can be understood from the context, it will be omitted from the notation, as in $[V]_\delta$. With this definition, the V -typical set is defined as

$$\mathcal{T}_K([V]_\delta | a^K) := \cup_{\tilde{V} \in [V]_\delta} \mathcal{T}_K(\tilde{V} | a^K) \quad (\text{B.5})$$

where $Q_A = \mathcal{P}(a^K)$ is implicit in the notation. Let $B^K \sim V^K(\cdot | a^K)$ where V^K is the K th product of V .

For brevity, we next denote

$$V(\mathcal{T}_K([V]_\delta | a^K) | a^K) \equiv \mathbb{P}[B^K \in \mathcal{T}_K([V]_\delta | a^K) | a^K]. \quad (\text{B.6})$$

Proposition 21. (Typical sets [11, Variation of Lemma 2.12 and Lemma 2.13]): Let $\delta > 0$ be given. Then,

$$V(\mathcal{T}_K([V]_\delta | a^K) | a^K) \geq 1 - 2|\mathcal{A}||\mathcal{B}|e^{-K\delta^2} \quad (\text{B.7})$$

and

$$\exp[K \cdot (H_{\mathcal{P}(a^K) \times V}(B | A) - \mu)] \leq \left| \mathcal{T}_K([V]_\delta | a^K) \right| = \exp[K \cdot (H_{\mathcal{P}(a^K) \times V}(B | A) + \mu)] \quad (\text{B.8})$$

where

$$\mu \equiv \mu_K \equiv |\mathcal{A}||\mathcal{B}| \left(\delta \log \frac{1}{\delta} + \frac{\log(K+1)}{K} \right). \quad (\text{B.9})$$

Prop. 21 implies that $V[\mathcal{T}_K([V]_\delta | a^K) | a^K] \rightarrow 1$ as $K \rightarrow \infty$ as long as $\delta \equiv \delta_K$ satisfies the *delta-convention* [11, Convention 2.11], that is $-\delta_K = o(1)$, $\delta_K = \omega(\frac{1}{\sqrt{K}})$. The constant in the order terms depend only on $|\mathcal{A}|, |\mathcal{B}|$. Henceforth, we assume that the delta-convention is satisfied, that μ_K is as in (B.9) and that δ_K is chosen to accommodate the largest alphabet sizes possible. For example, we will consider channels $\mathcal{A} \rightarrow \mathcal{B}^d$ where $d \leq \bar{d}$ for some bounded \bar{d} , and accordingly, δ_K is chosen to satisfy the delta convention for $|\mathcal{A}|, |\mathcal{B}|^d$. To lighten the notation, we will mostly write $\delta \equiv \delta_K$.

Remark 22. When $|\mathcal{A}| = 1$, that is, the input is deterministic, Prop. 21 and the discussion between them provide bounds on the probability and the size of typical sets. Following standard notation, we will omit in this case the conditioning variable, and use, $\mathcal{T}_K([Q_{A\bar{A}}]_{\delta_K})$, for example, for the typical set of $Q_{A\bar{A}}$.

B. The Molecule Distance Function and its Implications

As was stated in Prop. 21, the V -typical set $\mathcal{T}_K([V]_\delta | a^K) \subseteq \mathcal{B}^K$ has high probability when the output is drawn as $B^K \sim V^K(\cdot | a^K)$. We next explore the probability of the same V -typical set conditioned on a^K , when $B^K \sim V^K(\cdot | \bar{a}^K)$, that is, with a different channel input \bar{a}^K . We define a proper distance between a^K and \bar{a}^K , and show that if a^K and \bar{a}^K are “far” according to this distance, then this probability is exponentially small. On the other hand, we also show that if they are “close”, then this probability is still exponentially small, albeit with an arbitrarily small exponent.

The key issue is a proper choice of the distance measure, which is of course channel dependent. Specifically, for a joint type $Q_{A\bar{A}} \in \mathcal{P}_K(\mathcal{A} \times \mathcal{A})$ and a DMC $V: \mathcal{A} \rightarrow \mathcal{B}$, we define the distance function

$$\Delta(Q_{A\bar{A}}, V) := H_{Q_{A \times V}}(B | A) - \max_{Q_{B|A\bar{A}}: Q_{B|A} \in [V|Q_A]_\delta, Q_{B|\bar{A}} \in [V|Q_{\bar{A}}]_\delta} H_Q(B | A, \bar{A}). \quad (\text{B.10})$$

Let $Q_{A\bar{A}B}^*$ be the maximizer in (B.10). Since by definition $Q_{B|A}^* \in [V | Q_A]_\delta$ then its conditional entropy satisfies $H_{Q^*}(B | A) \approx H_{Q_A \times V}(B | A)$, that is, close to the conditional entropy induced by the channel V itself. Since conditioning reduces entropy $H_{Q^*}(B | A, \bar{A}) \lesssim H_{Q_A \times V}(B | A)$, and (approximate) equality is achieved when $Q_{\bar{A}|A}$ is the identity, noiseless, channel (this is however not the only case). In this case $\Delta(Q_{A\bar{A}}, V) \approx 0$. Thus, if $Q_{\bar{A}|A}$ is close to the identity, the distance is close to zero.

In what follows, we will consider a pair of inputs a^K and \bar{a}^K to be “close” if $\Delta(\mathcal{P}(a^K, \bar{a}^K), V) \leq \underline{\rho}_K$ where

$$\underline{\rho}_K := 2 \left[\delta_K^2 + \mu_K + |\mathcal{A}||\mathcal{B}|\delta_K \log \frac{1}{\delta_K} + \frac{3|\mathcal{A}||\mathcal{B}|\log K}{K} \right], \quad (\text{B.11})$$

and “far” otherwise. It should be stressed that by the delta-convention, $\underline{\rho}_K = o(1)$, and thus even a “far” pair of inputs may have in fact, normalized distance which tends to zero, albeit with a slow enough decay rate.

In the next three subsections we consider various implications of the distance function.

1) *Probability of a Typical Set Conditioned on Close v.s. Far Inputs:*

Lemma 23. *Let δ_K satisfy the delta-convention be given and ρ_K be given such that $\rho_K \geq \underline{\rho}_K$. Further, let $a^K, \bar{a}^K \in \mathcal{A}^K$ be given for some $K \in \mathbb{N}^+$. Then, there exists K_0 (which only depends on $|\mathcal{A}|, |\mathcal{B}|$) such that for all $K \geq K_0$ it holds that*

$$V(\mathcal{T}_K([V]_{\delta_K} | \bar{a}^K) | a^K) \leq e^{-K\rho_K/2} \quad (\text{B.12})$$

if $\Delta(\mathcal{P}(a^K, \bar{a}^K), V) \geq \rho_K$ and

$$V(\mathcal{T}_K([V]_{\delta_K} | \bar{a}^K) | a^K) \geq e^{-2K\rho_K} \quad (\text{B.13})$$

if $\Delta(\mathcal{P}(a^K, \bar{a}^K), V) < \rho_K$.

Proof: For brevity, we denote $\delta \equiv \delta_K, \mu \equiv \mu_K$ and $\rho \equiv \rho_K$. We first prove (B.12), and to this end, we upper bound the size of the intersection of a pair of V -shells given by $\tilde{V} \in [V | \mathcal{P}(a^K)]_\delta$ and $\bar{V} \in [V | \mathcal{P}(\bar{a}^K)]_\delta$. By the method of types

$$\left| \mathcal{T}_K(\tilde{V} | a^K) \cap \mathcal{T}_K(\bar{V} | \bar{a}^K) \right| = \sum_{Q_{B|A\bar{A}}} \left| \mathcal{T}_K(Q_{B|A\bar{A}} | a^K, \bar{a}^K) \right| \quad (\text{B.14})$$

$$\stackrel{(a)}{\leq} \sum_{Q_{B|A\bar{A}}} \exp \left[K \cdot H_{\mathcal{P}(a^K, \bar{a}^K) \times Q_{B|A\bar{A}}}(B | A, \bar{A}) \right] \quad (\text{B.15})$$

$$\leq |\mathcal{P}_K(\mathcal{B} | \mathcal{P}(a^K, \bar{a}^K))| \cdot \max_{Q_{B|A\bar{A}}} \exp \left[K \cdot H_Q(B | A, \bar{A}) \right] \quad (\text{B.16})$$

$$\stackrel{(b)}{\leq} |\mathcal{P}_K(\mathcal{B} | \mathcal{P}(a^K, \bar{a}^K))| \cdot \exp \left[K \cdot (H_{\mathcal{P}(a^K) \times V}(B | A) - \rho) \right] \quad (\text{B.17})$$

where the first two summations and the following maximization are over

$$\left\{ Q_{B|A\bar{A}} \in \mathcal{P}_K(\mathcal{B} | \mathcal{P}(a^K, \bar{a}^K)): Q_{B|A} = \tilde{V}, Q_{B|\bar{A}} = \bar{V} \right\}, \quad (\text{B.18})$$

(a) follows by a generalization of size of a V -shell in [11, Lemma 2.5] (for this specific result, see [11, Problem 2.10]), and (b) follows from the definition of $\Delta(Q_{A\bar{A}}, V)$ in (B.10), and the assumption $\Delta(Q_{A\bar{A}}, V) \geq \rho$.

Based on (B.17), we evaluate the V -probability of intersection of a pair of typical sets:

$$V \left(\mathcal{T}_K([V]_\delta | a^K) \cap \mathcal{T}_K([V]_\delta | \bar{a}^K) | a^K \right) = V \left(\bigcup_{\tilde{V} \in [V | \mathcal{P}(a^K)]_\delta, \bar{V} \in [V | \mathcal{P}(\bar{a}^K)]_\delta} \mathcal{T}_K(\tilde{V} | a^K) \cap \mathcal{T}_K(\bar{V} | \bar{a}^K) \middle| a^K \right) \quad (\text{B.19})$$

$$\stackrel{(a)}{\leq} \sum_{\tilde{V} \in [V | \mathcal{P}(a^K)]_\delta, \bar{V} \in [V | \mathcal{P}(\bar{a}^K)]_\delta} V \left(\mathcal{T}_K(\tilde{V} | a^K) \cap \mathcal{T}_K(\bar{V} | \bar{a}^K) \middle| a^K \right) \quad (\text{B.20})$$

$$\stackrel{(b)}{\leq} \sum_{\tilde{V} \in [V | \mathcal{P}(a^K)]_\delta, \bar{V} \in [V | \mathcal{P}(\bar{a}^K)]_\delta} \frac{|\mathcal{T}_K(\tilde{V} | a^K) \cap \mathcal{T}_K(\bar{V} | \bar{a}^K)|}{|\mathcal{T}_K(\tilde{V} | a^K)|} V \left(\mathcal{T}_K(\tilde{V} | a^K) \middle| a^K \right) \quad (\text{B.21})$$

$$\stackrel{(c)}{\leq} |\mathcal{P}_K(\mathcal{A} \times \mathcal{A} \times \mathcal{B})|^2 \sum_{\tilde{V} \in [V | \mathcal{P}(a^K)]_\delta} \frac{\exp \left[K \cdot (H_{\mathcal{P}(a^K) \times V}(B | A) - \rho) \right]}{|\mathcal{T}_K(\tilde{V} | a^K)|} V \left(\mathcal{T}_K(\tilde{V} | a^K) \middle| a^K \right) \quad (\text{B.22})$$

$$\stackrel{(d)}{\leq} |\mathcal{P}_K(\mathcal{A} \times \mathcal{A} \times \mathcal{B})|^2 \exp \left[K \cdot \left(\mu - \rho + |\mathcal{A}| |\mathcal{B}| \delta \log \frac{1}{\delta} + \frac{|\mathcal{A}| |\mathcal{B}| \log K}{K} \right) \right] \sum_{\tilde{V} \in [V | \mathcal{P}(a^K)]_\delta} V \left(\mathcal{T}_K(\tilde{V} | a^K) \middle| a^K \right) \quad (\text{B.23})$$

$$\stackrel{(e)}{\leq} \exp \left[K \cdot \left(\mu - \rho + |\mathcal{A}| |\mathcal{B}| \delta \log \frac{1}{\delta} + \frac{3|\mathcal{A}| |\mathcal{B}| \log K}{K} \right) \right] V \left(\mathcal{T}_K([V]_\delta | a^K) \middle| a^K \right) \quad (\text{B.24})$$

$$\stackrel{(f)}{\leq} e^{-K\rho/2} \quad (\text{B.25})$$

where (a) follows from the union bound, (b) follows since the V -probabilities of vectors which belong to the same V -shell $\mathcal{T}_K(\tilde{V} | a^K)$ are equal, (c) follows from (B.17), (d) follows since from the method-of-types bound on the size of a V -shell [11, Lemma 2.5]

$$|\mathcal{T}_K(\tilde{V} | a^K)| \geq \exp \left[K \cdot \left(H_{\mathcal{P}(a^K) \times V}(B | A) - \frac{|\mathcal{A}| |\mathcal{B}| \log K}{K} \right) \right] \quad (\text{B.26})$$

and since as was shown in [11, p. 22, proof of Lemma 2.13], if $\tilde{V} \in [V | \mathcal{P}(a^K)]_\delta$, then

$$\left| H_{\mathcal{P}(a^K) \times \tilde{V}}(B | A) - H_{\mathcal{P}(a^K) \times V}(B | A) \right| \leq |\mathcal{A}| |\mathcal{B}| \delta \log \frac{1}{\delta}, \quad (\text{B.27})$$

(e) follows again from type counting

$$|\mathcal{P}_K(\mathcal{A} \times \mathcal{A} \times \mathcal{B})| \leq (K+1)^{|\mathcal{A}|^2 |\mathcal{B}|} = \exp \left[|\mathcal{A}|^2 |\mathcal{B}| \cdot \log(K+1) \right] \quad (\text{B.28})$$

([11, Lemma 2.5]), and (f) from the assumption on ρ . Hence,

$$V \left(\mathcal{T}_K([V]_\delta | \bar{a}^K) \middle| a^K \right)$$

$$= V(\mathcal{T}_K([V]_\delta | \bar{a}^K) \cap \mathcal{T}_K([V]_\delta | a^K) | a^K) + V(\mathcal{T}_K([V]_\delta | \bar{a}^K) \cap \mathcal{T}_K^c([V]_\delta | a^K) | a^K) \quad (\text{B.29})$$

$$\leq V(\mathcal{T}_K([V]_\delta | \bar{a}^K) \cap \mathcal{T}_K([V]_\delta | a^K) | a^K) + V(\mathcal{T}_K^c([V]_\delta | a^K) | a^K) \quad (\text{B.30})$$

$$\stackrel{(a)}{\leq} e^{-K\rho/2} + e^{-K\delta^2} \leq e^{-K\rho/2} \quad (\text{B.31})$$

where (a) follows from (B.25) and Prop. 21 and (b) from the assumption $\rho > 2\delta^2$ [see (B.11)].

The reverse statement (B.13) is proved analogously, and so only the main steps are given (with fewer explanations). Analogously to (B.17) it holds that

$$\left| \mathcal{T}_K(\tilde{V} | a^K) \cap \mathcal{T}_K(\bar{V} | \bar{a}^K) \right| = \sum_{Q_{B|A\bar{A}}} \left| \mathcal{T}_K(Q_{B|A\bar{A}} | a^K, \bar{a}^K) \right| \quad (\text{B.32})$$

$$\geq |\mathcal{P}_K(\mathcal{B} | \mathcal{P}(a^K, \bar{a}^K))|^{-1} \sum_{Q_{B|A\bar{A}}} \exp \left[K \cdot H_{\mathcal{P}(a^K, \bar{a}^K) \times Q_{B|A\bar{A}}}(B | A, \bar{A}) \right] \quad (\text{B.33})$$

$$\geq |\mathcal{P}_K(\mathcal{B} | \mathcal{P}(a^K, \bar{a}^K))|^{-2} \cdot \max_{Q_{B|A\bar{A}}} \exp \left[K \cdot H_{\mathcal{P}(a^K, \bar{a}^K) \times Q_{B|A\bar{A}}}(B | A, \bar{A}) \right] \quad (\text{B.34})$$

$$> |\mathcal{P}_K(\mathcal{B} | \mathcal{P}(a^K, \bar{a}^K))|^{-2} \cdot \exp \left[K \cdot (H_{\mathcal{P}(a^K) \times V}(B | A) - \rho) \right]. \quad (\text{B.35})$$

with the maximization over the same set as in (B.17). Then, analogously to (B.25)

$$V(\mathcal{T}_K([V]_\delta | a^K) \cap \mathcal{T}_K([V]_\delta | \bar{a}^K) | a^K) = V \left(\bigcup_{\tilde{V} \in [V | \mathcal{P}(a^K)]_\delta, \bar{V} \in [V | \mathcal{P}(\bar{a}^K)]_\delta} \mathcal{T}_K(\tilde{V} | a^K) \cap \mathcal{T}_K(\bar{V} | \bar{a}^K) \middle| a^K \right) \quad (\text{B.36})$$

$$\geq \max_{\tilde{V} \in [V | \mathcal{P}(a^K)]_\delta, \bar{V} \in [V | \mathcal{P}(\bar{a}^K)]_\delta} V(\mathcal{T}_K(\tilde{V} | a^K) \cap \mathcal{T}_K(\bar{V} | \bar{a}^K) | a^K) \quad (\text{B.37})$$

$$= \max_{\tilde{V} \in [V | \mathcal{P}(a^K)]_\delta, \bar{V} \in [V | \mathcal{P}(\bar{a}^K)]_\delta} \frac{|\mathcal{T}_K(\tilde{V} | a^K) \cap \mathcal{T}_K(\bar{V} | \bar{a}^K)|}{|\mathcal{T}_K(\tilde{V} | a^K)|} V(\mathcal{T}_K(\tilde{V} | a^K) | a^K) \quad (\text{B.38})$$

$$\stackrel{(c)}{\geq} |\mathcal{P}_K(\mathcal{A} \times \mathcal{A} \times \mathcal{B})|^{-2} \max_{\tilde{V} \in [V | \mathcal{P}(a^K)]_\delta} \frac{\exp \left[K \cdot (H_{\mathcal{P}(a^K) \times V}(B | A) - \rho) \right]}{|\mathcal{T}_K(\tilde{V} | a^K)|} V(\mathcal{T}_K(\tilde{V} | a^K) | a^K) \quad (\text{B.39})$$

$$\stackrel{(d)}{\geq} |\mathcal{P}_K(\mathcal{A} \times \mathcal{A} \times \mathcal{B})|^{-2} \exp \left[K \cdot \left(-\rho - |\mathcal{A}||\mathcal{B}|\delta \log \frac{1}{\delta} \right) \right] \max_{\tilde{V} \in [V | \mathcal{P}(a^K)]_\delta} V(\mathcal{T}_K(\tilde{V} | a^K) | a^K) \quad (\text{B.40})$$

$$\geq |\mathcal{P}_K(\mathcal{A} \times \mathcal{A} \times \mathcal{B})|^{-3} \exp \left[K \cdot \left(-\rho - |\mathcal{A}||\mathcal{B}|\delta \log \frac{1}{\delta} \right) \right] \sum_{\tilde{V} \in [V | \mathcal{P}(a^K)]_\delta} V(\mathcal{T}_K(\tilde{V} | a^K) | a^K) \quad (\text{B.41})$$

$$\geq \exp \left[K \cdot \left(-\rho - |\mathcal{A}||\mathcal{B}|\delta \log \frac{1}{\delta} - \frac{3|\mathcal{A}||\mathcal{B}|\log K}{K} \right) \right] (1 - e^{-K\delta^2}) \quad (\text{B.42})$$

$$\geq e^{-2K\rho} \quad (\text{B.43})$$

for all K large enough. ■

2) *Equivocation of a Permutation for Far Inputs:* Even in a simplified DNA channel, in which $N = M$ and any molecule in the codeword is sampled exactly once ($S_m = 1$ for all $m \in [M]$) the decoder still faces an uncertainty regarding the *order* in which the molecules were sequenced (that is, the molecule index vector U^N). In this section, we show that if the input molecules are sufficiently far apart, then the decoder can infer some information regarding their order. To this end, we measure closeness according to the given the distance definition in (B.10), and utilize the characterization of typical set probability in Lemma 23. As said, the result refines [40, proof of Lemma 3].

We thus next focus on the following scenario, which involves a “large” number $T \in \mathbb{N}^+$ of an *ordered sequence of vectors* $a^{KT} = (a_0^K, a_1^K, \dots, a_{T-1}^K)$ so that $a_t^K \in \mathcal{A}^K$ for all $t \in [T]$, and a DMC $V: \mathcal{A} \rightarrow \mathcal{B}$.²² The order of the T vectors is permuted by a permutation $\Sigma: [T] \rightarrow [T]$ chosen uniformly at random from the symmetric group \mathfrak{S}_T to obtain $(a_{\Sigma(0)}^K, a_{\Sigma(1)}^K, \dots, a_{\Sigma(T-1)}^K)$. Then, each $a_{\Sigma(t)}^K$, $t \in [T]$ is input to the channel V according to order (a total of KT uses) and the result is $B^{KT} = (B_0^K, B_1^K, \dots, B_{T-1}^K)$ where $B_t^K \in \mathcal{B}^K$ and by the description above $B_t^K \sim V^K(\cdot | a_{\Sigma(t)}^K)$. The observer of the channel output is assumed to be aware of the input vectors, but not the permutation Σ . We next quantify the ability of the observer to re-order the output and essentially guess the permutation, in terms of its equivocation. Clearly, if the channel V is noiseless, and all a_t^K are different from one another, then perfect ordering is possible, with probability 1, and so $H(\Sigma | B^{KT}) = 0$. On the other hand, if the channel is extremely noisy (the output is independent of the input), or if a_t^K are all equal, then no information on the permutation is revealed by the channel to the observer. In that case

$$H(\Sigma | B^{KT}) = \log |\mathfrak{S}_T| = \log |T!| = T \log T - T + O(\log T) \quad (\text{B.44})$$

where the last equality is by Stirling’s approximation. The next lemma concerns an intermediate situation. It assumes that $a_{t_1}^K, a_{t_2}^K$ are “far” according to the definition of $\Delta(\mathcal{P}(a_{t_1}^K, a_{t_2}^K), V)$ in (B.10), for any $t_1, t_2 \in [T]$, $t_1 \neq t_2$, and that the channel can be noisy. In this case, it is shown that the entropy is $o(T \log T)$, that is, negligible compared to the first-order term $T \log T$. Importantly, this is shown for an exponential number of vectors, which scales as $T \geq e^{\tau_0 K}$ for some $\tau_0 > 0$.

Lemma 24. *Let T_K be such that $T_K \geq e^{K\tau_0}$ for some $\tau_0 > 0$ and all large enough K . Let $V: \mathcal{A} \rightarrow \mathcal{B}$ be a DMC, and let ρ_K be such that $\underline{\rho}_K \leq \rho_K < \tau_0$ for all large enough K (where $\underline{\rho}_K$ is as defined in (B.11)). Further let $(a_0^K, a_1^K, \dots, a_{T-1}^K) \subset (\mathcal{A}^K)^T$ be such that any pair of vectors is “far”, to wit*

$$\Delta(\mathcal{P}(a_{t_1}^K, a_{t_2}^K), V) \geq \underline{\rho}_K \quad (\text{B.45})$$

²²Here, K plays the role of the length of the molecule L , and T the number of molecules in a codeword M . However, when the result of the next Lemma 24 will be utilized to prove the upper bound on the capacity, we will set $K = L$ and T to be roughly M . Hence the different notation.

for any $t_1, t_2 \in [T]$ with $t_1 \neq t_2$. Moreover, let $\Sigma \sim \text{Uniform}(\mathfrak{S}_T)$ be a uniformly random permutation, and let $B_t^K \sim V^K(\cdot | a_{\Sigma(t)}^K)$ independently for all $t \in [T]$. Then, there exists K_0 such that for all $K \geq K_0$

$$H(\Sigma | B^{KT}) = o(T \log T). \quad (\text{B.46})$$

Proof: We denote $T = e^{\tau_K K}$ for $K \in \mathbb{N}^+$ such that according to the assumption of the lemma $\tau_K \geq \tau_0$ for all large enough K . From symmetry we may assume that Σ was drawn to be the identity permutation $\Sigma(t) = t$, and thus we (implicitly) assume in the rest of the proof that $B_t^K \sim V^K(\cdot | a_t^K)$, independently for all $t \in [T]$. Let $\delta_K > 0$ be given which defines the V -typical set $\mathcal{T}_K([V]_{\delta_K} | a_t^K)$.

When a_t^K is fed into the channel V there are two possible ‘‘bad’’ events to consider:

1) *A-typical output:* The channel output B_t^K is not V -typical conditioned on its input a_t^K , namely the event whose indicator is

$$e_t := \mathbb{1} \{ B_t^K \notin \mathcal{T}_K([V]_{\delta} | a_t^K) \}. \quad (\text{B.47})$$

2) *Large ambiguity output:* For some $t' \neq t$, B_t^K belongs to a large number of V -typical sets for inputs which are not a_t^K , namely the event whose indicator is

$$f_t := \mathbb{1} \left\{ \sum_{t' \in [T] \setminus \{t\}} \mathbb{1} \{ B_t^K \in \mathcal{T}_K([V]_{\delta} | a_{t'}^K) \} \geq T_0 \right\} \quad (\text{B.48})$$

where $T_0 > 0$ is a threshold that will be chosen later.

We next analyze the events related to $\{e_t\}_{t \in [T]}$ and $\{f_t\}_{t \in [T]}$. We begin by analyzing $\{e_t\}_{t \in [T]}$. By Prop. 21 $\mathbb{E}[e_t] \leq e^{-K\delta_K^2}$. We assume that K is large so that δ_K is sufficiently small so that $\tau_K > \tau_0 > \delta_K^2$. Thus, the expected of total number of atypical outputs is $\mathbb{E}[\sum_{t \in [T]} e_t] \leq e^{K(\tau_K - \delta_K^2)} = o(T)$ as $T = e^{K\tau_K}$ and δ_K satisfies the delta-convention. We now let

$$\mathcal{E} := \left\{ \sum_{t \in [T]} e_t \geq e^{K(\tau_K - \delta_K^2/2)} \right\} \quad (\text{B.49})$$

be the event that the total number of atypical events exceeds its expectation by a factor of more than $e^{K\delta_K^2/2}$. Then, since e_t are independent events, Chernoff’s bound implies that

$$\mathbb{P}[\mathcal{E}] \leq \exp \left[-e^{K\tau_K} \cdot d_b \left(e^{-K\delta_K^2/2} \parallel \mathbb{E}[e_t] \right) \right] \quad (\text{B.50})$$

$$\stackrel{(a)}{\leq} \exp \left[-e^{K\tau_K} \cdot e^{-K\delta_K^2/2} \left(\log \frac{e^{-K\delta_K^2/2}}{\mathbb{E}[e_t]} - 1 \right) \right] \quad (\text{B.51})$$

$$\leq \exp \left[-e^{K(\tau_K - \delta_K^2/2)} (K\delta_K^2/2 - 1) \right] \quad (\text{B.52})$$

where (a) follows from the bound $d_b(p_1 \parallel p_2) > p_1 (\log \frac{p_1}{p_2} - 1)$ for $p_1, p_2 \in [0, 1]$ [31, Sec. 6.3]. Since δ_K satisfies the delta-convention, it holds that $K\delta_K^2 = \omega(1)$ and hence the probability of \mathcal{E} decays double-exponentially

with K .

Next, we analyze the probability of the events $\{f_t\}_{t \in [T]}$, in a similar fashion to the previous analysis. For a single alternative vector $a_{t'}^K$ with $t' \neq t$ it holds from (B.12) (Lemma 23)

$$\mathbb{P} [B_t^K \in \mathcal{T}_K([V]_\delta | a_{t'}^K)] = V (\mathcal{T}_K([V]_\delta | a_{t'}^K) | a_t^K) \leq e^{-K\rho_K/2}, \quad (\text{B.53})$$

using the assumption that a_t^K and $a_{t'}^K$ are far, that is $\Delta(\mathcal{P}(a_t^K, a_{t'}^K), V) \geq \rho_K$ for $t \neq t'$, and for all K large enough. We further assume that K is large so that $\tau_K > \tau_0 > \rho_K$. Thus, by linearity of expectation

$$\mathbb{E} \left[\sum_{t' \in [T] \setminus \{t\}} \mathbb{1}\{B_t^K \in \mathcal{T}_K([V]_\delta | a_{t'}^K)\} \right] \leq e^{K(\tau_K - \rho_K/2)}, \quad (\text{B.54})$$

and then by Markov's inequality

$$\mathbb{E}[f_t] = \mathbb{P} \left[\sum_{t' \in [T] \setminus \{t\}} \mathbb{1}\{B_t^K \in \mathcal{T}_K([V]_\delta | a_{t'}^K)\} > T_0 \right] \leq \frac{e^{K(\tau_K - \rho_K/2)}}{T_0}. \quad (\text{B.55})$$

Thus, if we choose $T_0 = e^{K(\tau_K - \rho_K/4)}$ then the expected of total number of ‘‘large-ambiguity’’ outputs is

$$\mathbb{E} \left[\sum_{t \in [T]} f_t \right] \leq \frac{e^{K(2\tau_K - \rho_K/2)}}{e^{K(\tau_K - \rho_K/4)}} = e^{K(\tau_K - \rho_K/4)} = o(T) \quad (\text{B.56})$$

(as $T = e^{K\tau_K}$, and $\rho_K > 2\delta_K^2 = \omega(\frac{1}{K})$). We now let

$$\mathcal{F} := \left\{ \sum_{t \in [T]} f_t \geq e^{K(\tau_K - \rho_K/8)} \right\} \quad (\text{B.57})$$

be the event that the total number of atypical events exceeds its expectation by a factor of more than $e^{K\rho_K/8}$. Since f_t are independent events, Chernoff's bound implies that

$$\mathbb{P} [\mathcal{F}] \leq \exp \left[-e^{K\tau_K} \cdot d_b \left(e^{-K\rho_K/8} \parallel \mathbb{E}[f_t] \right) \right] \quad (\text{B.58})$$

$$\stackrel{(a)}{\leq} \exp \left[-e^{K\tau_K} \cdot e^{-K\rho_K/8} \left(\log \frac{e^{-K\delta_K^2/8}}{\mathbb{E}[f_t]} - 1 \right) \right] \quad (\text{B.59})$$

$$\leq \exp \left[-e^{K(\tau_K - \rho_K/8)} (K\rho_K/8 - 1) \right] \quad (\text{B.60})$$

where (a) follows from the bound $d_b(p_1 \parallel p_2) > p_1 (\log \frac{p_1}{p_2} - 1)$. By the assumption of the lemma, $\rho_K \geq \underline{\rho}_K$ defined in (B.11) and so, specifically, $\rho_K \geq 2\delta_K^2$. By the delta-convention $\delta_K^2 = \omega(\frac{1}{K})$ and hence the probability of \mathcal{F} decays double-exponentially with K .

We thus conclude that $\mathcal{G} = \mathcal{E} \cup \mathcal{F}$ decays double-exponentially with K , as by the union bound

$$\mathbb{P}[\mathcal{G}] \leq \mathbb{P}[\mathcal{E}] + \mathbb{P}[\mathcal{F}] \leq \exp \left[-e^{\Theta(K)} \right]. \quad (\text{B.61})$$

The equivocation of the permutation conditioned on B^{KT} is now upper bounded as

$$H(\Sigma | B^{KT}) \leq H(\Sigma, \mathcal{G} | B^{KT}) = h_b(\mathbb{P}[\mathcal{G}]) + \mathbb{P}[\mathcal{G}] \cdot H(\Sigma | B^{KT}, \mathcal{G}) + \mathbb{P}[\mathcal{G}^c] \cdot H(\Sigma | B^{KT}, \mathcal{G}^c). \quad (\text{B.62})$$

We next bound each term separately. For the first term $h_b(\mathbb{P}[\mathcal{G}]) \leq \log 2$, and for the second term, due to the double-exponential decay of the probability of \mathcal{G}

$$\mathbb{P}[\mathcal{G}] \cdot H(\Sigma | B^{KT}, \mathcal{G}) \leq \exp \left[-e^{\Theta(K)} \right] \log(T!) \quad (\text{B.63})$$

$$\leq \exp \left[-e^{\Theta(K)} \right] T \log T \quad (\text{B.64})$$

$$= \exp \left[-e^{\Theta(\log T)} \right] T \log T \quad (\text{B.65})$$

$$= o(T \log T). \quad (\text{B.66})$$

To complete the proof of the lemma, it suffices to show that the third term is $o(T \log T)$. To this end, we bound the equivocation under the event that $\mathcal{G}^c = \mathcal{E}^c \cap \mathcal{F}^c$ as follows. Under this event, there are at most $T_1 := e^{K(\tau_K - \delta_K^2/2)} + e^{K(\tau_K - \rho_K/8)} = o(e^{K\tau_K}) = o(T)$ output sequences B_t^K which are either ‘‘a-typical’’ to their input or have ‘‘large-ambiguity’’ as they are typical to many inputs. We say that an output B_t^K is ‘‘bad’’ if either of the two occurs, that is, if either $e_t = 1$ or $f_t = 1$ (and ‘‘good’’ otherwise). Note, however, that observer, which is aware of both $(a_t^K)_{t \in [T]}$ and $(B_t^K)_{t \in [T]}$ (but not of the permutation Σ) cannot determine if B_t^K is bad or not (that would require the knowledge that Σ is the identity permutation and that it is a_t^K which was the channel input that resulted the output B_t^K). Nonetheless, we next upper bound the total number of permutations which have non-zero probability conditioned on \mathcal{G}^c , and then further upper bound the conditional entropy by the logarithm of the number of such permutations.

Consider the set of permutations which are constructed as follows:

- 1) The number of bad indices is chosen. There are at most T_1 possibilities for this choice. We denote the number of bad indices by \tilde{T}_1 .
- 2) Given a choice of a total of exactly \tilde{T}_1 bad indices, each index $t \in [T]$ is labeled as bad or good. There are at most $\binom{T}{\tilde{T}_1} \leq \binom{T}{T_1}$ possibilities for this choice.
- 3) For any t currently labeled as good find, at most $T_0 = e^{K(\tau_K - \rho_K/4)} = o(T)$ arbitrary indices $t' \in [T]$ such that $B_t^K \in \mathcal{T}_K([V]_\delta | a_{t'}^K)$. There are at most T^{T_0} possibilities for this choice, and there are at most T total good indices. Thus, the number of choices for the permutation mapping to the good output indices is at most $T \cdot T^{T_0}$.
- 4) Given the association of the $T - \tilde{T}_1$ good indices, choose the \tilde{T}_1 remaining values of the permutation. There are at most $\tilde{T}_1! \leq T_1! \leq T_1 \log T_1$ possibilities for this choice.

It is easy to verify that conditioned on \mathcal{G}^c , the true permutation belongs to one of this possibilities constructed above, with probability 1. Thus, the entropy of the permutation is bounded by the logarithm of its support.

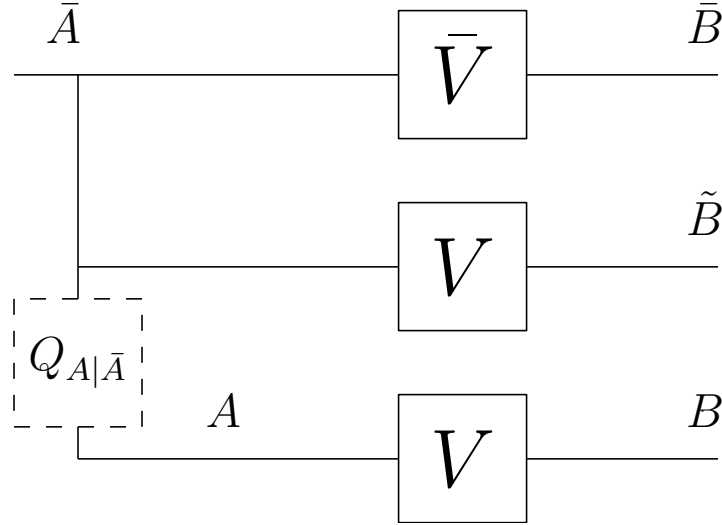

Figure 7. Channel model for a pair of “close” inputs

Hence, from the above count of possible permutations

$$\mathbb{P}[\mathcal{G}^c] \cdot H(\Sigma | B^{KT}, \mathcal{G}^c) \leq 1 \cdot H(\Sigma | B^{KT}, \mathcal{G}^c) \quad (\text{B.67})$$

$$\leq \log \left[T_1 \cdot \binom{T}{T_1} \cdot T^{T_0+1} \cdot T_1! \right] \quad (\text{B.68})$$

$$\stackrel{(a)}{\leq} \log T_1 + T h_b \left(\frac{T_1}{T} \right) + (T_0 + 1) \log T + T_1 \log T_1 \quad (\text{B.69})$$

$$\stackrel{(b)}{\leq} \log T_1 + T \cdot \log 2 + (T_0 + 1) \log T + T_1 \log T_1 \quad (\text{B.70})$$

$$\stackrel{(c)}{=} o(T \log T) \quad (\text{B.71})$$

where (a) follows from the entropy bound on the binomial coefficient $\binom{n}{k} \leq e^{n h_b(k/n)}$ for $n \geq k$ integers, and (b) follows from $h_b(\epsilon) \leq \log 2$, and (c) follows since $T_0 = o(T)$ and $T_1 = o(T)$. ■

3) *Common Input Mutual Information Deficit for Close Inputs:* A possible way of overcoming the ordering problem in the DNA channel mentioned in the previous section, is to send codewords in which many of identical molecules, or even just similar. In the extreme case, when all input molecules x_m^L are equal, then the ordering is of course immaterial. However, sending the same input in a memoryless channel reduces the output entropy, and thus the achievable mutual information. In this section, we focus on such mutual information for a pair of molecules. We show that if the molecules are “close” according to the distance (B.10), then, up to lower order terms, the resulting mutual information is as if the two inputs are *identical*, which, in turn, is strictly less than the mutual information achieved for a pair of independent inputs. As the discussion is general we use general notation, not necessarily the one of the DNA channel.

Specifically, we focus on the scenario depicted in Fig. 7, where we assume throughout this section that $Q_A = Q_{\bar{A}}$.

Consider the pair of DMCs \bar{V} and the lower V in Fig. 7, and suppose that $Q_{A|\bar{A}}$ is a DMC too. Clearly, to maximize $I(A, \bar{A}; B, \bar{B})$ the channel $Q_{A|\bar{A}}$ should be chosen so that A and \bar{A} are *independent* – the resulting mutual information is the sum of the mutual-information in each of the channels. At the other extreme, if $Q_{A|\bar{A}}$ is restricted to be a noiseless channel, $A = \bar{A}$, and this *common* input in fact minimizes the mutual information $I(A, \bar{A}; B, \bar{B})$. In this case, B, \bar{B} are two conditionally independent observations of the same input (as in the binomial channel of Definition 4). We may thus define the CID of a *pair* of channels V, \bar{V} and input distribution Q_A as

$$\text{CID}(Q_{\bar{A}}, V, \bar{V}) := I_{Q_{\bar{A}} \times V}(\bar{A}; \tilde{B}) + I_{Q_{\bar{A}} \times \bar{V}}(\bar{A}; \bar{B}) - I_{Q_{\bar{A}\bar{B}\tilde{B}}}(\bar{A}; \bar{B}, \tilde{B}) \quad (\text{B.72})$$

where the first two terms represent the total mutual information obtained by independent inputs to V, \bar{V} (with the same input distribution $Q_{\bar{A}}$) and the last term represents the total mutual information obtained by a common input to V and \bar{V} given by $A = \bar{A}$. The definition (B.72) slightly generalizes the definition of the CID for a single channel V in (21), where with a slight abuse of notation, it agrees with the convention that $\text{CID}(Q_{\bar{A}}, V, V) \equiv \text{CID}(Q_{\bar{A}}, V)$.

The following proposition provides a useful characterization of $\text{CID}(Q_{\bar{A}}, V, \bar{V})$.

Proposition 25. *Let $V: \mathcal{A} \rightarrow \mathcal{B}$ and $\bar{V}: \mathcal{A} \rightarrow \bar{\mathcal{B}}$ be a pair of DMCs, let $Q_{\bar{A}} \in \mathcal{P}(\mathcal{A})$ and let $\bar{B} \sim \bar{V}(\cdot | \bar{A})$ and $\tilde{B} \sim V(\cdot | \bar{A})$. Then, $\text{CID}(Q_{\bar{A}}, V, \bar{V}) = I(\bar{B}; \tilde{B}) \geq 0$ and equality holds if and only if either V or \bar{V} are completely noisy.*

Proof: Under the given distributions (see Fig. 7), Markovity implies that

$$I(\bar{A}; \bar{B}, \tilde{B}) = I(\bar{A}; \bar{B}) + I(\bar{A}; \tilde{B} | \bar{B}) \quad (\text{B.73})$$

$$= I(\bar{A}; \bar{B}) + H(\tilde{B} | \bar{B}) - H(\tilde{B} | \bar{A}). \quad (\text{B.74})$$

Then, by standard identities

$$\text{CID}(Q_{\bar{A}}, V, \bar{V}) = H(\tilde{B}) - H(\tilde{B} | \bar{B}) = I(\bar{B}; \tilde{B}) \geq 0 \quad (\text{B.75})$$

Since $\bar{B} - \bar{A} - \tilde{B}$ holds, $I(\bar{B}; \tilde{B}) = 0$ if and only if \bar{B} and \tilde{B} are independent, which occurs if and only if either $I(\bar{A}; \bar{B}) = 0$ or $I(\bar{A}; \tilde{B}) = 0$. ■

Corollary 26. *Let $V: \mathcal{A} \rightarrow \mathcal{B}$ be a DMC which is not completely noisy for $Q_{\bar{A}}$ (i.e., $I(Q_{\bar{A}}, V) > 0$) and let $V^{\oplus d_1}$ and $V^{\oplus d_2}$ be its binomial extensions for some $d_1, d_2 \geq 1$. Then,*

$$\text{CID}(Q_{\bar{A}}, V^{\oplus d_1}, V^{\oplus d_2}) \geq \text{CID}(Q_{\bar{A}}, V). \quad (\text{B.76})$$

This property follows by applying the data processing theorem to the mutual information representation of the CID in Prop. 25.

For the DNA channel, we will encounter the case in which $Q_{A|\bar{A}}$ is such that the inputs A and \bar{A} are “close” (in terms of the distance $\Delta(Q_{A\bar{A}}, V)$ defined in the previous section), but not exactly identical. As the next proposition shows, for small enough distance $\Delta(Q_{A\bar{A}}, V)$, the resulting mutual information asymptotically behaves as the mutual information achieved by a common input, and thus it is *strictly lower* compared to independent inputs, by an amount of $\text{CID}(Q_{\bar{A}}, V, \bar{V})$ (plus an additional negligible term).

Proposition 27. *Let $V: \mathcal{A} \rightarrow \mathcal{B}$ and $\bar{V}: \mathcal{A} \rightarrow \bar{\mathcal{B}}$ be a pair of discrete channels such that V satisfies*

$$\nu_{\min}(V) := \max_{a \in \mathcal{A}, b \in \mathcal{B}} \log \frac{1}{V(b|a)} < \infty. \quad (\text{B.77})$$

Further let $Q_{A\bar{A}}$ be such that $Q_A = Q_{\bar{A}}$ and $\Delta(Q_{A\bar{A}}, V) \leq \rho_K$ where ρ_K is as defined in (B.11).

If $A^K, \bar{A}^K \in \mathcal{A}^K$ are random inputs such that $\mathcal{P}(A^K, \bar{A}^K) = Q_{A\bar{A}}$ with probability 1, and $B^K \sim V^K(\cdot | A^K)$ and $\bar{B}^K \sim \bar{V}^K(\cdot | \bar{A}^K)$ where $B^K \in \mathcal{B}^K$ and $\bar{B}^K \in \bar{\mathcal{B}}^K$, then,

$$I(A^K, \bar{A}^K; B^K, \bar{B}^K) \leq K \cdot \left[I_Q(\bar{A}; \bar{B}, \tilde{B}) + o_{\nu_{\min}(V)}(1) \right] \quad (\text{B.78})$$

$$= K \cdot \left[I_{Q_A \times V}(\bar{A}; \tilde{B}) + I_{Q_{\bar{A}} \times \bar{V}}(\bar{A}; \bar{B}) - \text{CID}(Q_{\bar{A}}, V, \bar{V}) + o_{\nu_{\min}(V)}(1) \right] \quad (\text{B.79})$$

where $Q_{B|A} = V$ and $Q_{\bar{B}|\bar{A}} = Q_{\bar{B}|\bar{A}} = \bar{V}$.

To prove Prop. 27 we will need the following lemma, which is concerned with a single-letter joint output entropy:

Lemma 28. *Assume that $V, \bar{V}, Q_{A\bar{A}}$ satisfy the conditions of Prop. 27, with $\Delta(Q_{A\bar{A}}, V) \leq \rho$. If $(A, \bar{A}) \sim Q_{A\bar{A}}$, $\bar{B} \sim \bar{V}(\cdot | \bar{A})$, $B \sim V(\cdot | A)$ and $\tilde{B} \sim V(\cdot | \bar{A})$ (as in Fig. 7) then,*

$$H(B, \bar{B}) \leq H(\tilde{B}, \bar{B}) + O(\rho). \quad (\text{B.80})$$

Proof: We prove the claim by showing that if $\Delta(Q_{A\bar{A}}, V) = \Delta(Q_{\bar{A}\bar{A}}, V) \leq \rho \rightarrow 0^{23}$ then $|H(B, \bar{B}) - H(\tilde{B}, \bar{B})| \rightarrow 0$. Let $P_{A\bar{A}\tilde{B}\bar{B}}$ and $P_{A\bar{A}B\bar{B}}$ be the distributions of the relevant random variables. The entropy difference is upper bounded by the total variation between the corresponding distributions as [11, Lemma 2.7]²⁴

$$\left| H(B, \bar{B}) - H(\tilde{B}, \bar{B}) \right| \leq -|P_{\tilde{B}\bar{B}} - P_{B\bar{B}}| \cdot \log \frac{|P_{\tilde{B}\bar{B}} - P_{B\bar{B}}|}{|\mathcal{B}|^2}. \quad (\text{B.81})$$

In turn, the total variation is bounded by Pinsker’s inequality (e.g. [11, Problem 3.18])

$$|P_{\tilde{B}\bar{B}} - P_{B\bar{B}}| \leq \sqrt{2 \log 2 \cdot D(P_{\tilde{B}\bar{B}} \| P_{B\bar{B}})} \quad (\text{B.82})$$

and so it suffices to show that $D(P_{\tilde{B}\bar{B}} \| P_{B\bar{B}}) \rightarrow 0$ as $\rho \rightarrow 0$. While this property pertains to single-letter

²³The equality follows from the assumption $Q_A = Q_{\bar{A}}$.

²⁴The logarithmic term is not sharp, and can be removed by using the refined bound [11, Problem 3.10]. This is however inconsequential for the proof.

distributions of (\bar{B}, \tilde{B}) and (B, \bar{B}) , it will be convenient to prove it by considering K dimensional vectors $A^K, \bar{A}^K \in \mathcal{A}^K$, $B^K, \tilde{B}^K \in \mathcal{B}^K$ and $\bar{B}^K \in \bar{\mathcal{B}}^K$ whose marginals $(A_k, \bar{A}_k, B_k, \tilde{B}_k, \bar{B}_k)$ are distributed i.i.d. according to $P_{A\bar{A}B\tilde{B}\bar{B}}$. We further set δ_K to satisfy the delta-convention, and let $\rho \equiv \rho_K = \underline{\rho}_K$ where $\underline{\rho}_K$ is as defined in (B.11) and satisfies $\underline{\rho}_K = o(1)$. Then, the proof of the lemma is completed by showing that $D(P_{\tilde{B}^K \bar{B}^K} \parallel P_{B^K \bar{B}^K}) = K \cdot D(P_{\tilde{B}\bar{B}} \parallel P_{B\bar{B}}) = o(K)$, substituting it to (B.82) and the resulting bound in (B.81).

Let $P_{A^K \bar{A}^K \tilde{B}^K \bar{B}^K}$ and $P_{A^K \bar{A}^K B^K \bar{B}^K}$ be the resulting K dimensional (product) distributions of the relevant random variables. To complete the proof it is thus required to upper bound the KL divergence $D(P_{\tilde{B}^K \bar{B}^K} \parallel P_{B^K \bar{B}^K})$, and to this end, we first prove several properties.

Property 1: Recall that it is assumed that $\Delta(Q_{A\bar{A}}, V) \leq \rho_K$. We show that a similar bound holds for joint distributions of $\check{Q}_{A\bar{A}} \in [Q_{A\bar{A}}]_{\delta_K}$ which are typical to the memoryless distribution $Q_{A\bar{A}}$, to wit, satisfy

$$|\check{Q}_{A\bar{A}}(a, \bar{a}) - Q_{A\bar{A}}(a, \bar{a})| \leq \delta_K, \quad \forall (a, \bar{a}) \in \mathcal{A} \times \bar{\mathcal{A}}. \quad (\text{B.83})$$

Clearly in this case $\check{Q}_A \in [Q_A]_{\delta_K \cdot |\mathcal{A}|}$ also holds (see, e.g., [11, Lemma 2.10]). The conditional entropy is known to be continuous in the input distribution, and so, as in [11, p. 22, proof of Lemma 2.13],

$$\left| H_{Q_A \times V}(B | A) - H_{\check{Q}_A \times V}(B | A) \right| \leq \delta_K |\mathcal{A}| \cdot \log |\mathcal{B}|, \quad (\text{B.84})$$

and, similarly,

$$\left| H_{Q_{A\bar{A}} \times Q_{B|A\bar{A}}}(B | A, \bar{A}) - H_{\check{Q}_{A\bar{A}} \times Q_{B|A\bar{A}}}(B | A, \bar{A}) \right| \leq \delta_K \log |\mathcal{B}| \quad (\text{B.85})$$

for any $Q_{B|A\bar{A}} \in \mathcal{P}(\mathcal{B} | \mathcal{A} \times \bar{\mathcal{A}})$. Hence, by the assumption $\Delta(Q_{A\bar{A}}, V) \leq \rho_K$ [see the distance definition in (B.10)]

$$\Delta(\check{Q}_{A\bar{A}}, V) = \Delta(Q_{A\bar{A}}, V) + \Delta(\check{Q}_{A\bar{A}}, V) - \Delta(Q_{A\bar{A}}, V) \quad (\text{B.86})$$

$$\begin{aligned} &\leq \Delta(Q_{A\bar{A}}, V) + \left| H_{Q_A \times V}(B | A) - H_{\check{Q}_A \times V}(B | A) \right| \\ &\quad + \max_{Q_{B|A\bar{A}}} \left| H_{Q_{A\bar{A}} \times Q_{B|A\bar{A}}}(B | A, \bar{A}) - H_{\check{Q}_{A\bar{A}} \times Q_{B|A\bar{A}}}(B | A, \bar{A}) \right| \end{aligned} \quad (\text{B.87})$$

$$\leq \rho_K + \delta_K (|\mathcal{A}| + 1) \log |\mathcal{B}| := \rho'_K. \quad (\text{B.88})$$

By the delta-convention, $\rho'_K = o(1)$. The bound (B.88) is the first required property.

Property 2: We relate the typical sets $\mathcal{T}_K([V]_{\delta_K} | a^K) \subseteq \mathcal{B}^K$ and $\mathcal{T}_K([V]_{\delta_K} | \bar{a}^K)$ for $(a^K, \bar{a}^K) \in \mathcal{T}_K([Q_{A\bar{A}}]_{\delta_K})$ which are ‘‘close’’ according to the Δ -distance, and specifically, according to Property 1 satisfy that $\Delta(\mathcal{P}(a^K, \bar{a}^K), V) \leq \rho'_K$. To this end, note that Lemma 23 (with the role of a^K and \bar{a}^K switched) implies that

$$V^K (\mathcal{T}_K([V]_{\delta} | a^K) | \bar{a}^K) \geq e^{-2K\rho'_K} \quad (\text{B.89})$$

where $\rho'_K = o(1)$ holds. Denote the *Hamming neighborhood* of a set $\mathcal{S}_K \subset \mathcal{B}^K$ by

$$\Gamma^\ell \mathcal{S}_K := \left\{ \tilde{b}^K \in \mathcal{B}^K : \min_{b^K \in \mathcal{S}_K} \rho_H(\tilde{b}^K, b^K) \leq \ell \right\} \quad (\text{B.90})$$

where $\rho_H(\cdot, \cdot)$ is the Hamming distance. By the non-asymptotic *blowing-up lemma* [37, Lemma 3.6.1] (see also [11, Lemma 5.4] [29], [30])

$$V^K \left(\Gamma^{\ell_K} \mathcal{T}_K([V]_\delta | a^K) \mid \bar{a}^K \right) \geq 1 - \frac{1}{K^2} \quad (\text{B.91})$$

where $\frac{\ell_K}{K} = \sqrt{\rho'_K} + \sqrt{\frac{\log K}{K}} = o(1)$.²⁵ The probability bound of (B.91) is the second required property.

Property 3: If $\tilde{b}^K \in \Gamma^{\ell_K} \mathcal{T}_K([V]_\delta | a^K)$ then there exists $\check{b} \in \mathcal{T}_K([V]_\delta | a^K)$ such that $\rho_H(\tilde{b}^K, \check{b}^K) \leq \ell_K$. It then follows from the definition of $\nu_{\min}(V)$ that

$$\frac{V^K(\tilde{b}^K | a^K)}{V^K(\check{b}^K | a^K)} \geq e^{-\ell_K \nu_{\min}}. \quad (\text{B.92})$$

This is the third required property.

Property 4: We upper bound the ratio $\frac{V^K(\tilde{b}^K | \bar{a}^K)}{V^K(\check{b}^K | a^K)}$ for $\tilde{b}^K \in \mathcal{T}_K([V]_{\delta_K} | \bar{a}^K) \cap \Gamma^{\ell_K} \mathcal{T}_K([V]_{\delta_K} | a^K)$. First, we upper bound $V(\tilde{b}^K | \bar{a}^K)$ for $\tilde{b}^K \in \mathcal{T}_K([V]_{\delta_K} | \bar{a}^K)$. There exists $\check{V} \in [V | Q_{\bar{A}}]_\delta \subset \mathcal{P}_K(\mathcal{B} | Q_{\bar{A}})$ such that $\tilde{b}^K \in \mathcal{T}_K(\check{V} | \bar{a}^K)$ and so

$$V^K(\tilde{b}^K | \bar{a}^K) = \exp \left[-K \cdot \left(D(\check{V} \| V | Q_{\bar{A}}) + H_{Q_{\bar{A}} \times \check{V}}(B | \bar{A}) \right) \right] \quad (\text{B.93})$$

$$\leq \exp \left[-K \cdot \left(-|\mathcal{A}||\mathcal{B}|\delta_K \log \delta_K + H_{Q_{\bar{A}} \times V}(B | \bar{A}) \right) \right] \quad (\text{B.94})$$

where the equality follows from the standard identity [11, Lemma 2.6], and the inequality follows from the continuity of the conditional entropy in the channel that determines the relation between the variables [11, Proof of Lemma 2.13], as well as the non-negativity of the KL divergence. Second, we lower bound $V^K(\tilde{b}^K | a^K)$ for $\tilde{b}^K \in \Gamma^{\ell_K} \mathcal{T}_K([V]_\delta | a^K)$. By Property 3 there exists $\check{V} \in \mathcal{P}_K(\mathcal{B} | Q_A)$ and $\check{b}^K \in \mathcal{T}_K(\check{V} | a^K) \subset \mathcal{T}_K([V]_{\delta_K} | a^K)$ such that

$$V^K(\tilde{b}^K | a^K) \geq e^{-\ell_K \nu_{\min}} \cdot V^K(\check{b}^K | a^K) \geq \exp \left[-K \cdot \left(\frac{\ell_K}{K} \nu_{\min} + \nu_{\min} \delta_K |\mathcal{A}||\mathcal{B}| + H_{Q_A \times V}(B | A) \right) \right] \quad (\text{B.95})$$

where the right-most inequality follows from

$$\begin{aligned} \frac{1}{K} \log V^K(\check{b}^K | a^K) &= \sum_{a \in \text{supp}(Q_A)} Q_A(a) \sum_{b \in \text{supp}(V(\cdot | a))} \check{V}(b | a) \cdot \log V(b | a) \\ &\leq \sum_{a \in \text{supp}(Q_A)} Q_A(a) \sum_{b \in \text{supp}(V(\cdot | a))} V(b | a) \cdot \log V(b | a) \end{aligned} \quad (\text{B.96})$$

²⁵With the choice $\alpha = 1$ in [37, Eq. 3.6.5] which leads in the notation there to $\eta_K = \frac{1}{K^2}$.

$$+ \sum_{a \in \text{supp}(Q_A)} Q_A(a) \sum_{b \in \text{supp}(V(\cdot|a))} |\tilde{V}(b|a) - V(b|a)| \cdot \log \frac{1}{V(b|a)} \quad (\text{B.97})$$

$$\leq \sum_{a \in \text{supp}(Q_A)} Q_A(a) \sum_{b \in \text{supp}(V(\cdot|a))} V(b|a) \cdot \log V(b|a) + \nu_{\min} \delta_K |\mathcal{A}| |\mathcal{B}| \quad (\text{B.98})$$

$$= -H_{Q_A \times V}(B|A) + \nu_{\min} \delta_K |\mathcal{A}| |\mathcal{B}|. \quad (\text{B.99})$$

Combining (B.94) and (B.95), it holds that if $\tilde{b}^K \in \mathcal{T}_K([V] | \bar{a}^K) \cap \Gamma^{\ell_K} \mathcal{T}_K([V]_{\delta_K} | a^K)$, and $Q_A = Q_{\bar{A}}$ then

$$\frac{V^K(\tilde{b}^K | \bar{a}^K)}{V^K(\tilde{b}^K | a^K)} \leq \exp \left[K \cdot \left(\frac{\ell_K}{K} \nu_{\min} + \nu_{\min} \delta_K |\mathcal{A}| |\mathcal{B}| - |\mathcal{A}| |\mathcal{B}| \delta_K \log \delta_K \right) \right]. \quad (\text{B.100})$$

This is the fourth required property.

With the above four properties, we now bound the required KL divergence, as follows:

$$D(P_{\tilde{B}^K \bar{B}^K} \| P_{B^K \bar{B}^K}) \stackrel{(a)}{\leq} D(P_{\tilde{B}^K \bar{B}^K | A^K \bar{A}^K} \| P_{B^K \bar{B}^K | A^K \bar{A}^K} | P_{A^K \bar{A}^K}) \quad (\text{B.101})$$

$$\stackrel{(b)}{\leq} \sum_{(a^K, \bar{a}^K) \in \mathcal{T}_K([Q_{A\bar{A}}])} P_{A^K \bar{A}^K}(a^K, \bar{a}^K) \cdot D \left(P_{\tilde{B}^K \bar{B}^K | A^K \bar{A}^K}(\cdot | a^K, \bar{a}^K) \| P_{B^K \bar{B}^K | A^K \bar{A}^K}(\cdot | a^K, \bar{a}^K) \right) + e^{-K\delta_K^2} \quad (\text{B.102})$$

$$\stackrel{(c)}{=} \sum_{(a^K, \bar{a}^K) \in \mathcal{T}_K([Q_{A\bar{A}}])} P_{A^K \bar{A}^K}(a^K, \bar{a}^K) \times \sum_{\tilde{b} \in \mathcal{B}^K} \sum_{\bar{b} \in \mathcal{B}^K} V^K(\tilde{b} | \bar{a}^K) \cdot \bar{V}^K(\bar{b} | \bar{a}^K) \log \frac{V^K(\tilde{b} | \bar{a}^K) \cdot \bar{V}^K(\bar{b} | \bar{a}^K)}{V^K(\tilde{b} | a^K) \cdot V^K(\bar{b} | \bar{a}^K)} \quad (\text{B.103})$$

$$= \sum_{(a^K, \bar{a}^K) \in \mathcal{T}_K([Q_{A\bar{A}}])} P_{A^K \bar{A}^K}(a^K, \bar{a}^K) \cdot \sum_{\tilde{b} \in \mathcal{B}^K} V^K(\tilde{b}^K | \bar{a}^K) \log \frac{V^K(\tilde{b}^K | \bar{a}^K)}{V^K(\tilde{b}^K | a^K)} + e^{-K\delta_K^2} \quad (\text{B.104})$$

where (a) follows from the convexity of the KL divergence [8, Theorem 2.7.2], (b) follows since $\mathbb{P}[(a^K, \bar{a}^K) \in \mathcal{T}_K^c([Q_{A\bar{A}}])] \leq e^{-K\delta_K^2}$ under $P_{A^K \bar{A}^K}$, and (c) follows from (see Fig. 7)

$$P_{\tilde{B}^K \bar{B}^K | A^K \bar{A}^K}(\tilde{b}^K, \bar{b}^K | a^K, \bar{a}^K) = V^K(\tilde{b}^K | \bar{a}^K) \cdot \bar{V}^K(\bar{b}^K | \bar{a}^K) \quad (\text{B.105})$$

and

$$P_{B^K \bar{B}^K | A^K \bar{A}^K}(\tilde{b}^K, \bar{b}^K | a^K, \bar{a}^K) = V^K(\tilde{b}^K | a^K) \cdot \bar{V}^K(\bar{b}^K | \bar{a}^K). \quad (\text{B.106})$$

We next bound the KL divergence in (B.104) for an arbitrary $(a^K, \bar{a}^K) \in \mathcal{T}_K([Q_{A\bar{A}}])$. The idea is that under the measure $V^K(\cdot | \bar{a}^K)$, both the typical set $\mathcal{T}_K([V] | \bar{a}^K)$ and the blown-up set $\Gamma^{\ell_K} \mathcal{T}_K([V]_{\delta} | a^K)$ have high probability (larger than $1 - e^{-K\delta_K^2}$ and $1 - 1/K^2$, respectively). Thus their intersection also has high probability

(larger than $1 - e^{-K\delta_K^2} - 1/K^2$). Using this observation we may bound the conditional KL divergence as follows:

$$\begin{aligned} & \sum_{\tilde{b}^K \in \mathcal{B}^K} V^K(\tilde{b}^K | \bar{a}^K) \log \frac{V^K(\tilde{b}^K | \bar{a}^K)}{V^K(\tilde{b}^K | a^K)} \\ & \stackrel{(a)}{\leq} \sum_{\tilde{b}^K \in \mathcal{T}_K([V]|\bar{a}^K) \cap \Gamma^{\ell_K} \mathcal{T}_K([V]_\delta|a^K)} V^K(\tilde{b} | \bar{a}^K) \log \frac{V^K(\tilde{b} | \bar{a}^K)}{V^K(\tilde{b} | a^K)} + \left(e^{-K\delta_K^2} + \frac{1}{K^2} \right) \cdot K \nu_{\min} \end{aligned} \quad (\text{B.107})$$

$$\stackrel{(b)}{\leq} \left[\frac{\ell_K}{K} \nu_{\min} + \nu_{\min} \delta_K |\mathcal{A}| |\mathcal{B}| - |\mathcal{A}| |\mathcal{B}| \delta_K \log \delta_K + \left(e^{-K\delta_K^2} + \frac{1}{K^2} \right) \nu_{\min} \right] \cdot K \quad (\text{B.108})$$

$$\stackrel{(c)}{=} o(K) \quad (\text{B.109})$$

where (a) follows since

$$\frac{1}{K} \log \frac{V^K(\tilde{b}^K | \bar{a}^K)}{V^K(\tilde{b}^K | a^K)} \leq \max_{a, \bar{a} \in \text{supp}(Q_A), \tilde{b} \in \mathcal{B}} \log \frac{V(\tilde{b} | \bar{a})}{V(\tilde{b} | a)} \leq \nu_{\min}, \quad (\text{B.110})$$

(b) follows from Property 4, and (c) follows since δ_K satisfies the delta convention, and $\ell_K = o(K)$. Inserting this bound back to (B.104) we obtain that $D(P_{\tilde{B}^K \bar{B}^K} \| P_{B^K \bar{B}^K}) = o(K)$, as was required to be proved in order to complete the proof of the lemma. \blacksquare

We now prove Prop. 27.

Proof of Prop. 27: Let $P_{A^K \bar{A}^K}$ denote the joint probability distribution of (A^K, \bar{A}^K) and let us explicitly denote the dependence of the mutual information on this distribution as $I(A^K, \bar{A}^K; B^K, \bar{B}^K) \equiv I(P_{A^K \bar{A}^K}, (V^K, \bar{V}^K))$. Under the assumption of the proposition, $P_{A^K \bar{A}^K}$ is supported on (a subset of) $\mathcal{T}_K(Q_{A\bar{A}})$. For a permutation $\sigma: [K] \rightarrow [K]$ from the symmetric group \mathfrak{S}_K , let

$$P_{A^K \bar{A}^K}^{(\sigma)}((a_0, \dots, a_{K-1}), (\bar{a}_0, \dots, \bar{a}_{K-1})) := P_{A^K \bar{A}^K}((a_{\sigma(0)}, \dots, a_{\sigma(K-1)}), (\bar{a}_{\sigma(0)}, \dots, \bar{a}_{\sigma(K-1)})). \quad (\text{B.111})$$

Then, $P_{A^K \bar{A}^K}^{(\sigma)}$ is also supported on a subset of $\mathcal{T}_K(Q_{A\bar{A}})$. Since $B^K \sim V^K(\cdot | A^K)$ and $\bar{B}^K \sim \bar{V}^K(\cdot | \bar{A}^K)$ and the channels V^K, \bar{V}^K are memoryless, then

$$I(P_{A^K \bar{A}^K}, (V^K, \bar{V}^K)) = I(P_{A^K \bar{A}^K}^{(\sigma)}, (V^K, \bar{V}^K)) \quad (\text{B.112})$$

for any $\sigma \in \mathfrak{S}_K$. Letting $\bar{P}_{A^K \bar{A}^K} := \frac{1}{|\mathfrak{S}_K|} \sum_{\sigma \in \mathfrak{S}_K} P_{A^K \bar{A}^K}^{(\sigma)}$ denote a uniform averaging over all permutations in \mathfrak{S}_K , the concavity of the mutual information in its input distribution and (B.112) imply

$$I(P_{A^K \bar{A}^K}, (V^K, \bar{V}^K)) \leq I(\bar{P}_{A^K \bar{A}^K}, (V^K, \bar{V}^K)). \quad (\text{B.113})$$

To bound the mutual information for $\bar{P}_{A^K \bar{A}^K}$ we note that under this distribution, $(A^K, \bar{A}^K) \sim \text{Uniform}[\mathcal{T}_K(Q_{A\bar{A}})]$, and so the distribution of a marginal pair is $(A_k, \bar{A}_k) \sim Q_{A\bar{A}}$ for any $k \in [K]$. By the standard bound on mutual

information for the memoryless channel $(A, \bar{A}) \rightarrow (B, \bar{B})$ it holds that

$$I\left(P_{A^K \bar{A}^K}, (V^K, \bar{V}^K)\right) \leq K \cdot I_{Q_{A\bar{A}} \times Q_{B|A} \times Q_{\bar{B}|\bar{A}}}(A, \bar{A}; B, \bar{B}) \quad (\text{B.114})$$

where $Q_{B|A} = V$ and $Q_{\bar{B}|\bar{A}} = \bar{V}$. We next bound the single-letter expression $I(A, \bar{A}; B, \bar{B})$ where the subscript defining the distribution Q is omitted for brevity. From Markovity (see Fig. 7)

$$I(A; B, \bar{B} | \bar{A}) = H(B, \bar{B} | \bar{A}) - H(B, \bar{B} | A, \bar{A}) \quad (\text{B.115})$$

$$= H(\bar{B} | \bar{A}) + H(B | \bar{B}, \bar{A}) - H(\bar{B} | A, \bar{A}) - H(B | \bar{B}, A, \bar{A}) \quad (\text{B.116})$$

$$= H(\bar{B} | \bar{A}) + H(B | \bar{A}) - H(\bar{B} | \bar{A}) - H(B | A) \quad (\text{B.117})$$

$$= H(B | \bar{A}) - H(B | A). \quad (\text{B.118})$$

Then,

$$I(A, \bar{A}; B, \bar{B}) = I(\bar{A}; B, \bar{B}) + I(A; B, \bar{B} | \bar{A}) \quad (\text{B.119})$$

$$= H(B, \bar{B}) - H(B, \bar{B} | \bar{A}) + I(A; B, \bar{B} | \bar{A}) \quad (\text{B.120})$$

$$= H(B, \bar{B}) - H(\bar{B} | \bar{A}) - H(B | \bar{A}, \bar{B}) + I(A; B, \bar{B} | \bar{A}) \quad (\text{B.121})$$

$$\stackrel{(a)}{=} H(B, \bar{B}) - H(\bar{B} | \bar{A}) - H(B | \bar{A}) + I(A; B, \bar{B} | \bar{A}) \quad (\text{B.122})$$

$$\stackrel{(b)}{=} H(B, \bar{B}) - H(\bar{B} | \bar{A}) - H(B | A) \quad (\text{B.123})$$

$$\stackrel{(c)}{=} H(B, \bar{B}) - H(\bar{B} | \bar{A}) - H(\tilde{B} | \bar{A}) \quad (\text{B.124})$$

$$\stackrel{(d)}{\leq} H(\tilde{B}, \bar{B}) - H(\bar{B} | \bar{A}) - H(\tilde{B} | \bar{A}) + o(\rho) \quad (\text{B.125})$$

$$\stackrel{(a)}{=} H(\bar{B}) + H(\tilde{B} | \bar{B}) - H(\bar{B} | \bar{A}) - H(\tilde{B} | \bar{A}, \bar{B}) + o(\rho) \quad (\text{B.126})$$

$$= I(\bar{A}; \bar{B}) + I(\bar{A}; \tilde{B} | \bar{B}) + o(\rho) \quad (\text{B.127})$$

$$= I(\bar{A}; \bar{B}, \tilde{B}) + o(\rho), \quad (\text{B.128})$$

where (a) follows from Markovity (see Fig. 7), (b) follows from (B.118), (c) follows since the fact that $Q_A = Q_{\bar{A}}$, and (d) follows from Lemma 28. Plugging this bound into (B.114) leads to the required result. ■

C. Structural Properties of Capacity Achieving Codebooks

In this section, we return to the DNA channel formulation, and show that if a rate R is achievable by a sequence of codebooks \mathcal{C}_M (and appropriate decoders), then it is also achievable by a sequence of codebooks which have convenient structural properties.

The first structural property regards the *minimum-distance maximal sets* of the codewords, which we define next. Recall the distance definition of $\Delta(Q_{A\bar{A}}, V)$ in (B.10) which we now utilize with $K = L$. For any given

codeword $x^{LM}(j)$ in a codebook \mathcal{C}_M , we define the *minimum-distance maximal set* $\mathcal{M}_\rho(j) \subseteq [M]$ as the largest subset of $[M]$ such that

$$\Delta(\mathcal{P}(x_{m_1}^L(j), x_{m_2}^L(j)), W^{\oplus d}) \geq \rho \quad (\text{B.129})$$

for all $m_1, m_2 \in \mathcal{M}_\rho(j)$, and so $x_{m_1}^L(j)$ and $x_{m_2}^L(j)$ are “far” according to the distance Δ . Furthermore, by the maximal property of this set, it is clear that if $m \notin \mathcal{M}_\rho(j)$, then there exists $m' \in \mathcal{M}_\rho(j)$ such that $x_m^L(j)$ and $x_{m'}^L(j)$ are “close”. Thus the size of $\mathcal{M}_\rho(j)$ is a measure of the scattering of the molecules of the codeword $x^{LM}(j)$. In principle, the index set $\mathcal{M}_\rho(j)$ can be different for each codeword $j \in [|\mathcal{C}_M|]$. However, as we show a sequence of capacity achieving codebooks can be found for which $\mathcal{M}_\rho(j) = [M_\rho]$, that is, identical to all the codewords $j \in [|\mathcal{C}_M|]$ in \mathcal{C}_M .

The second structural property is that the molecules of the codeword in a specific index $m \in [M]$ can have a constant composition $P_{X,m} \in \mathcal{P}_L(\mathcal{X})$, again, for all $j \in [|\mathcal{C}_M|]$.

These properties are summarized in the following proposition.

Proposition 29. *Suppose that the rate R is achievable for the DNA channel $\text{DNA} = \{\alpha, \beta, W\}$. Then R is also achievable by a sequence of codebooks $\{\mathcal{C}_M\}_{M \in \mathbb{N}^+}$ for which:*

- 1) *There exists M_ρ such that $\mathcal{M}_\rho(j) = [M_\rho]$ for all $j \in [|\mathcal{C}_M|]$.*
- 2) *There exists $\{P_{X,m}\}_{m \in [M]} \subseteq \mathcal{P}_L(\mathcal{X})$ (with $L = \beta \log M$) such that $\mathcal{P}(x_m^L(j)) = P_{X,m}$ for all $j \in [|\mathcal{C}_M|]$.*

Proof: The result is a simple consequence of the number of possibilities for sets \mathcal{M}_ρ , and for the number of types, as well as the DNA channel property that the order of the molecules does not affect the error probability of the codebook. We will establish those properties in two stages. In each stage we find a suitable sub-codebook which satisfies the property and has negligible rate loss, and, trivially, lower error probability (under optimal decoding).

Let a codebook \mathcal{C}_M of size $e^{ML(R-\delta)}$ be given. First, the number of possible sets $\mathcal{M}_\rho(j) \subseteq [M]$ is at most $2^M = e^{o(ML)}$ since $L = \beta \log M$. Thus, for all M large enough, there must exist a sub-code \mathcal{C}_M^* of size larger than

$$|\mathcal{C}_M^*| \geq \frac{e^{ML(R-\delta)}}{2^M} \geq \exp \left[ML \left(R - \frac{\delta}{2} \right) \right] \quad (\text{B.130})$$

such that $\mathcal{M}_\rho(j)$ is identical to all codewords. We denote its size by M_ρ . By re-ordering the molecules for each codeword, we may assure that $\mathcal{M}_\rho(j) = [M_\rho]$. Second, the number of possible types for each molecule $x_m^L(j) \in \mathcal{X}^L$ is less than $(L+1)^{|\mathcal{X}|}$ and so the number of sequences of M ordered types for a codeword is less than

$$(L+1)^{|\mathcal{X}|M} = \exp \left[ML \cdot \frac{|\mathcal{X}|M \cdot \log(L+1)}{ML} \right] = e^{o(ML)}. \quad (\text{B.131})$$

A proper sub-code can be found similarly to the first stage. ■

We will henceforth assume that the codebooks $\{\mathcal{C}_M\}$ satisfy the structural properties of Prop. 29.

D. Upper Bound on the Mutual Information

In this section, we derive an upper bound on $I(X^{LM}; Y^{LN})$, and so complete the proof of the upper bound on the capacity. To this end, we consider a genie-aided decoder proposed in [25], [40], and specifically, we assume that the genie-aided decoder has a modified output \tilde{Y}^{LM} instead of Y^{LN} , as we next define. Let $Z_m^{LS_m}$ be the *output clusters* of the molecule X_m^L , that is

$$Z_m^{LS_m} := \{Y_n^L : U_n = m\} \quad (\text{B.132})$$

is the set of outputs which are the result of the sequencing of the m th molecule. Note $Z_m^{LS_m} \in \mathcal{Y}^{LS_m}$, that is, Z_m has a variable number of LS_m symbols from \mathcal{Y} , where S_m is the number of times molecule m have been sampled. Thus, whenever $S_m = d$, we may consider Z_m to be the L -tuple output of L memoryless uses of the binomial channel $W^{\oplus d}$, for the input molecule X_m^L . So, we equivalently consider $Z_m^{LS_m}$ to have L of symbols from \mathcal{Y}^d , and slightly change the notation to Z_m^L . We then let $Z^{ML} = (Z_0^L, \dots, Z_{M-1}^L)$ (where each Z_m might have a different alphabet \mathcal{Y}^{S_m}). As discussed in [25], [40], a genie-aided decoder whose output is Z^{ML} is too strong, and would lead to a loose upper bound. So, we only assume that the decoder knows a random permutation of Z^{ML} . In other words, the decoder knows the outputs clusters, but does not know which input molecule is the source of which cluster. Concretely, let $\tilde{U}^M: [M] \rightarrow [M]$ be a permutation drawn uniformly at random from the symmetric group \mathfrak{S}_M , and let

$$\tilde{Y}_m^L = Z_{\tilde{U}_m}^L \in \mathcal{Y}^{S_{\tilde{U}_m}L} \quad (\text{B.133})$$

for all $m \in [M]$, and then consider the vector $\tilde{Y}^{LM} = (\tilde{Y}_0^L, \dots, \tilde{Y}_{M-1}^L)$. This is illustrated in Fig. 8

We assume that the output of the genie-aided channel is \tilde{Y}^{LM} rather than Y^{LN} . Note that this also implies that the genie-aided decoder knows the amplification vector Q^{N+1} , that is, how many molecules have been sampled d times for $d \in [N+1]$. This assumption essentially transforms the DNA channel as follows: On the original DNA channel with the original decoder, the M input molecules $\{X_m^L\}_{m \in [M]}$ are transformed into output molecules $\{Y_n^L\}_{n \in [N]}$, where each Y_n^L is the result of $X_{U_n}^L$ sequenced by the DMC W^L . In the modified channel, there are only M outputs \tilde{Y}^{LM} , and each output \tilde{Y}_m is the result of $X_{\tilde{U}_m}^L$ sequenced by the binomial channel, $W^{\oplus d}$, where $d = S_{\tilde{U}_m}$, and \mathcal{Y}^d is the alphabet size of \tilde{Y}_m^L . In other words, while the original DNA channel had N homogeneous outputs – each is a sequencing of a single molecule, the modified channel has M possibly non-homogeneous outputs – each is a (possibly) multiple sequencing of the same molecule.

Evidently, given \tilde{Y}^{LM} , the genie-aided decoder can generate an output which is distributed as Y^{LN} by separating its clusters and performing a random permutation. Hence, by the data processing theorem

$$I(X^{LM}; Y^{LN}) \leq I(X^{LM}; \tilde{Y}^{LM}). \quad (\text{B.134})$$

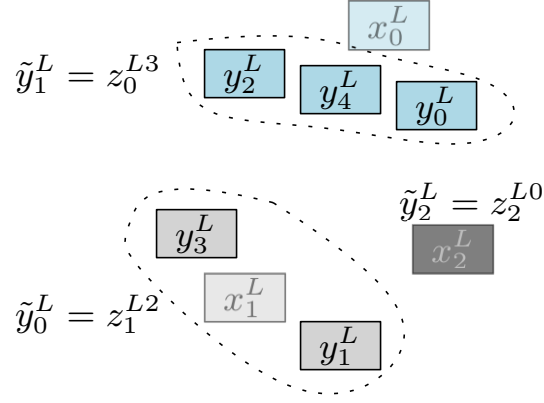

Figure 8. Illustration of permuted output clusters for $M = 3$ and $N = 5$. Here, $z_0^{L3} = (y_0^L, y_2^L, y_4^L)$, $z_1^{L2} = (y_1^L, y_3^L)$ and $z_2^{L0} = ()$ (is empty), while $\tilde{u}^3 = (1, 0, 2)$.

Thus in what follows we concentrate on upper bounding $I(X^{LM}; \tilde{Y}^{LM})$. Moreover, since the genie-aided decoder, in fact, is aware of Q^{N+1} , we will focus on bounding $I(X^{LM}; \tilde{Y}^{LM} | Q^{N+1})$ [which also satisfies a data processing bound as in (B.134)]. The error probability in the DNA channel depends on U^N only via Q^{N+1} . Thus Q^{N+1} can be considered a random state of the channel. Since Q_d is the number of molecules which have been sampled d times, or, otherwise stated, were input to a d -order binomial channel, Q^{N+1} represents the distribution of channel “quality” for the M molecules (with d being larger means that the channel is less noisy). We thus upper bound the mutual information $I(X^{LM}; \tilde{Y}^{LM} | Q^{N+1})$ in three steps:

- 1) Appendix B-D1: Conditioned on a fixed given amplification vector $Q^{N+1} = q^{N+1}$, and assuming a fixed composition codebook \mathcal{C}_M , namely, $\mathcal{P}(x_m^L(j)) = P_X$ for all $m \in [M]$, and for all $j \in [\mathcal{C}_M]$. (per the structural property of Prop. 29).
- 2) Appendix B-D2: Averaged over the distribution of Q^{N+1} , while still assuming a fixed composition codebook.
- 3) Appendix B-D3: Averaged over the distribution of Q^{N+1} , for a general composition codebook. Per the structural property of Prop. 29, it can still be assumed that $\mathcal{P}(x_m^L(j_1)) = \mathcal{P}(x_m^L(j_2))$ for any $j_1, j_2 \in [\mathcal{C}_M]$ and any $m \in [M]$.

The order in which we develop the upper bound on the mutual information is not arbitrary, or just chosen for the convenience of the analysis. Allowing a general composition codebook at an earlier stage of the derivation would lead to an upper bound in which a different input distribution $P_{X,d}$ can be chosen for input molecules which are sampled d times. Clearly, such a bound will not be generally tight in a DNA channel, in which the encoder does not how many times each molecule is sampled.

1) *Fixed Composition Molecules and Given Q^{N+1}* : We next upper bound the mutual information for a DNA channel with genie-aided decoder. We will need a slight generalization of the original model, which pertains to the molecule scaling length. For the DNA channel, there are M molecules, each of length $L = \beta \log M$. Here

we still assume that $L = \beta \log M$, yet the total number of molecules is $\theta_M M$ for a general $\theta_M \in (0, 1]$, which may even decay to zero, yet sub-polynomially.

Proposition 30. *Let $\bar{M} = \theta M$ for some $\theta \equiv \theta_M = \frac{1}{M^{o(1)}} \in (0, 1]$, and assume a DNA codebook with molecules of length $L = \beta \log M$ and a total of \bar{M} molecules per codeword. Let $\bar{d} \in \mathbb{N}^+$ and $q^{N+1} \in \mathcal{Q}(M, N)$ be given, and assume that*

$$\nu_{\min}(W) := \max_{x \in \mathcal{X}, y \in \mathcal{Y}} \log \frac{1}{W(y|x)} < \infty. \quad (\text{B.135})$$

Further assume that $\mathcal{P}(X_m^L) = P_X$ with probability 1. Then,

$$\frac{1}{\bar{M}L} I(X^{L\bar{M}}; \tilde{Y}^{L\bar{M}} | Q^{N+1} = q^{N+1}) \leq \sum_{d \in [\bar{d}]} \frac{q_d}{\bar{M}} \cdot J_d(P_X, W, \beta) + \left(1 - \sum_{d \in [\bar{d}]} \frac{q_d}{\bar{M}}\right) \log |\mathcal{X}| + o_{\bar{d}, |\mathcal{X}|}(1) \quad (\text{B.136})$$

where $J_d(P_X, W, \beta)$ is as defined in (B.1).

To prove Prop. 30, we need the following lemma which bounds $I(X^{LM}; \tilde{Y}^{LM} | Q^{N+1} = q^{N+1})$ in case all molecules have been sampled the same number of times d , that is, under the event, $S_m = d$ for all $m \in [M]$, and so the total number of output molecules is dM . Note that in the DNA channel $N = \alpha M$ and so $d = \alpha$ in this event, yet here we consider a general d .

Lemma 31. *Let $\bar{M} = \theta M$ for some $\theta \equiv \theta_M = \frac{1}{M^{o(1)}} \in (0, 1]$, and assume a DNA codebook with molecules of length $L = \beta \log M$ and a total of \bar{M} molecules per codeword. Assume that the codebook $\mathcal{C}_{\bar{M}}$ is such that $\mathcal{P}(x_m(j)) = P_X$ for all $m \in [\bar{M}]$ and $j \in [|\mathcal{C}_{\bar{M}}|]$ and that the sequencing channel satisfies $\nu_{\min}(W) < \infty$. Let q^{N+1} be given such that $q_d = M$ for some $d \in [N+1]$ (that is $S_m = d$ for all $m \in [M]$).*

If $X^{L\bar{M}}$ is uniformly distributed over $\mathcal{C}_{\bar{M}}$ then

$$\begin{aligned} & \frac{1}{\bar{M}L} I(X^{L\bar{M}}; \tilde{Y}^{L\bar{M}} | Q^{N+1} = q^{N+1}) \\ & \leq \begin{cases} I(P_X, W^{\oplus d}) - \frac{1}{\beta} + o(1), & \text{CID}(P_X, W^{\oplus d}) \geq \frac{2}{\beta} \\ I(P_X, W^{\oplus d}) - \text{CID}(P_X, W^{\oplus d}) + \frac{1}{\beta} + o(1) & \frac{1}{\beta} \leq \text{CID}(P_X, W^{\oplus d}) < \frac{2}{\beta} \\ I(P_X, W^{\oplus d}) & \text{CID}(P_X, W^{\oplus d}) < \frac{1}{\beta} \end{cases} \quad (\text{B.137}) \end{aligned}$$

We remark that the following proof utilizes Lemma 41 from Appendix C-C, which shows that the mutual information obtained by K DMC uses is roughly the same when the input distribution is i.i.d. and when the input has a fixed composition over the type class induced by the input distribution. This result may be of independent interest.

Proof: To simplify the notation, we remove throughout the conditioning on $Q^{N+1} = q^{N+1}$, and simply write M instead of $\bar{M} = \theta M$. The exact location in which this matters will be highlighted.

We begin by modifying the input distribution. Recall that the distribution of the input X^{LM} is

$$p_{\mathcal{C}_M}(x^{LM}) = \frac{1}{|\mathcal{C}_M|} \sum_{j \in [|\mathcal{C}_M|]} \mathbb{1}\{x^{LM}(j) = x^{LM}\}. \quad (\text{B.138})$$

Let us denote $x_m^L(j) = (x_{m,0}(j), \dots, x_{m,L-1}(j))$ so that $x_{m,\ell}(j) \in \mathcal{X}$ is the ℓ th symbol in the m th molecule of the codeword $x^{LM}(j)$. Let $x_{m,\sigma}(j) = (x_{m,\sigma(0)}(j), \dots, x_{m,\sigma(L-1)}(j))$, where $\sigma: [L] \rightarrow [L]$ is a permutation from the symmetric group \mathfrak{S}_L . Let $\mathcal{C}_{M,\sigma}$ denote the codebook obtained by applying the same permutation σ to all molecules, and for all codewords. Further let us temporarily denote the mutual information, $I(X^{LM}; \tilde{Y}^{LM})$, with an input distribution $P_{\mathcal{C}_M}$ as $I(P_{\mathcal{C}_M})$. Then, since the sequencing channel is memoryless $I(P_{\mathcal{C}_M}) = I(P_{\mathcal{C}_{M,\sigma}})$ for any permutation $\sigma \in \mathfrak{S}_L$. Let

$$\bar{P} = \frac{1}{|\mathfrak{S}_L|} \sum_{\sigma \in \mathfrak{S}_L} P_{\mathcal{C}_{M,\sigma}} \quad (\text{B.139})$$

denote the uniform mixture of $P_{\mathcal{C}_{M,\sigma}}$. By concavity of the mutual information in its input distribution, it holds that $I(\bar{P}) \geq I(P_{\mathcal{C}_M})$. Thus we may upper bound $I(\bar{P}) = I(X^{LM}; \tilde{Y}^{LM})$ under the input distribution \bar{P} . Note that under \bar{P} the marginal distribution of any molecule X_m^L is uniform over the type class $\mathcal{T}_L(P_X)$. Other than that, the order of the molecules is unchanged, and the closeness relations between molecules (according to the distance Δ) are unaltered.

Recall that \tilde{U}^M is the random permutation which maps X_m^L to $\tilde{Y}_{\tilde{U}_m^{-1}}^L$. It holds that

$$I(X^{LM}; \tilde{Y}^{LM}) = H(\tilde{Y}^{LM}) - H(\tilde{Y}^{LM} | X^{LM}) \quad (\text{B.140})$$

$$= H(\tilde{Y}^{LM}) - H(\tilde{Y}^{LM} | X^{LM}, \tilde{U}^M) - H(\tilde{Y}^{LM} | X^{LM}) + H(\tilde{Y}^{LM} | X^{LM}, \tilde{U}^M) \quad (\text{B.141})$$

$$= H(\tilde{Y}^{LM}) - H(\tilde{Y}^{LM} | X^{LM}, \tilde{U}^M) - I(\tilde{Y}^{LM}; \tilde{U}^M | X^{LM}) \quad (\text{B.142})$$

$$= H(\tilde{Y}^{LM}) - H(\tilde{Y}^{LM} | X^{LM}, \tilde{U}^M) - H(\tilde{U}^M | X^{LM}) + H(\tilde{U}^M | X^{LM}, \tilde{Y}^{LM}) \quad (\text{B.143})$$

$$= H(\tilde{Y}^{LM}) - H(\tilde{Y}^{LM} | X^{LM}, \tilde{U}^M) - M \log M + H(\tilde{U}^M | X^{LM}, \tilde{Y}^{LM}) + O(M) \quad (\text{B.144})$$

where the last equality follows since the permutation \tilde{U}^M is distributed uniformly over the symmetric group \mathfrak{S}_M , independently of X^{LM} , and since by Stirling's approximation $H(\tilde{U}^M) = \log M! \geq M \log M + O(M)$.

We continue by bounding $H(\tilde{U}^M | X^{LM}, \tilde{Y}^{LM})$ and to this end we recall the distance $\Delta(Q_{A\bar{A}}, V)$ defined in (B.10), and set $\rho_L \equiv \underline{\rho}_L$ obtained by setting $K = L$ in (B.11), and taking δ_L which satisfies the delta-convention for alphabet as large as $\mathcal{X} \times \mathcal{Y}^d$. In essence, we will utilize here Lemma 24, which implies that if a set of far molecules is randomly permuted and then sequenced, the permutation can be ‘‘decoded’’ by observing the inputs and the outputs in the sense that the conditional entropy of the permutation is greatly reduced conditioned on the input and the output. Recall that according to Prop. 29, we may assume that there exists $M_\rho \in [M]$ such that

$$\Delta\left(\mathcal{P}(x_{m_1}^L(j), x_{m_2}^L(j)), W^{\oplus d}\right) \geq \rho_L \quad (\text{B.145})$$

for all $m_1, m_2 \in [M_\rho]$ $m_1 \neq m_2$, and that for any $m_3 \notin [M_\rho]$ there exists $m_4 \in [M_\rho]$ such that²⁶

$$\Delta \left(\mathcal{P}(x_{m_3}^L(j), x_{m_4}^L(j)), W^{\oplus d} \right) \leq \rho_L. \quad (\text{B.146})$$

Thus, $\{x_m^L(j)\}_{m \in [M_\rho]}$ is a minimum-distance maximal set for any $j \in [|\mathcal{C}_M|]$. Let $G^M \in \{0, 1\}^M$ be such that $G_m = \mathbb{1}\{\tilde{U}_m \notin [M_\rho]\}$, that is, G_m indicates whether \tilde{Y}_m is the output of a molecule which does not belong to the minimum-distance maximal set. Given G^M the decoder can partition each of X^{LM} , \tilde{Y}^{LM} and \tilde{U}^M into two parts. Intuitively, the knowledge of G^m allows to separate the input, output and channel permutation to ones which pertain to the maximal set and their complement. Concretely, first $X_{[M_\rho]} = (X_0^L, \dots, X_{M_\rho-1}^L)$ and $X_{[M_\rho]^c} = (X_{M_\rho}^L, \dots, X_{M-1}^L)$ are, respectively, the molecules which belong to the maximal set, and the remaining molecules. Second, in accordance, $\tilde{Y}_{(0)} = (\tilde{Y}_m^L : G_m = 0)$ and $\tilde{Y}_{(1)} = (\tilde{Y}_m^L : G_m = 1)$, the outputs clusters which are the result of sequencing $X_{[M_\rho]}$ and $X_{[M_\rho]^c}$, respectively, and $\tilde{U}_{(0)} = (U_m : G_m = 0)$ and $\tilde{U}_{(1)} = (U_m : G_m = 1)$. It holds that $\tilde{U}_{(0)}$ (respectively $\tilde{U}_{(1)}$) is distributed uniformly over a group isomorphic to the symmetric group \mathfrak{S}_{M_ρ} (respectively $\mathfrak{S}_{[M] \setminus [M_\rho]}$).

Let $\eta \in (0, 1)$ be a given constant (which does not depend on M). Then, for all sufficiently large M ²⁷

$$\begin{aligned} H(\tilde{U}^M | X^{LM}, \tilde{Y}^{LM}) &\leq H(\tilde{U}^M, G^M | X^{LM}, \tilde{Y}^{LM}) \\ &= H(G^M | X^{LM}, \tilde{Y}^{LM}) + H(\tilde{U}^M | G^M, X^{LM}, \tilde{Y}^{LM}) \end{aligned} \quad (\text{B.147})$$

$$\leq H(G^M) + H(\tilde{U}_{(1)} | G^M, X^{LM}, \tilde{Y}^{LM}) + H(\tilde{U}_{(0)} | G^M, X^{LM}, \tilde{Y}^{LM}) \quad (\text{B.148})$$

$$\stackrel{(a)}{\leq} M \log 2 + (M - M_\rho) \log M + O(M) + H(\tilde{U}_{(0)} | G^M, X^{LM}, \tilde{Y}^{LM}) \quad (\text{B.149})$$

$$\stackrel{(b)}{\leq} O(M) + (M - M_\rho) \log M + H(\tilde{U}_{(0)} | X_{[M_\rho]}, \tilde{Y}_{(0)}) \quad (\text{B.150})$$

$$\stackrel{(c)}{\leq} O(M) + (M - M_\rho) \log M + o(M_\rho \log M_\rho) \quad (\text{B.151})$$

$$\leq O(M) + (M - M_\rho) \log M + o(M \log M) + \eta M \log M. \quad (\text{B.152})$$

where:

- (a) follows since $H(G^M) \leq \sum_{m \in [M]} H(G_m) \leq M \log 2$, and since $\tilde{U}_{(1)}$ has at most $(M - M_\rho)!$ outcomes and so Stirling's bound implies $H(\tilde{U}_{(1)} | G^M, X^{LM}, \tilde{Y}^{LM}) \leq \log(M - M_\rho)! \leq (M - M_\rho) \log M + O(M)$,
- (b) follows since conditioning reduces entropy.
- (c) is justified as follows. If $M_\rho \geq \eta M$ then we utilize Lemma 24. Indeed, $\tilde{U}_{(0)}$ is a uniform random permutation, $X_{[M_\rho]}$ is a set of ‘‘far’’ inputs, and $\tilde{Y}_{(0)}$ is the set of corresponding permuted outputs over the channel $W^{\oplus d}$. Specifically, we set therein $K = L = \beta \log M$. However, at this point we recall that M is a simplified notation for $\theta_M M$, and so we set $T = \eta \theta M \geq \exp[L(\frac{1}{\beta} - \frac{1}{L} \log(\frac{1}{\eta \theta M}))]$. It then holds that τ_L

²⁶Note that since $\mathcal{P}(x_{m_3}(j)) = \mathcal{P}(x_{m_4}(j))$ the distance Δ is symmetric.

²⁷The minimal value of M required for this to hold only depends on $|\mathcal{X}|, |\mathcal{Y}|, \bar{d}$ and η .

therein satisfies $\tau_L \geq \frac{1}{2\beta} = \tau_0$ for all L large enough (or M) since η is a constant and $\theta_M = \omega(\frac{1}{L})$. Thus, the claim of Lemma 24 applies here and results

$$H(\tilde{U}_{(0)} | X_{[M_\rho]}, \tilde{Y}_{(0)}) = o(M_\rho \log M_\rho). \quad (\text{B.153})$$

This is the only place in the proof in which it matters that θ may not equal 1. Otherwise, if $M_\rho \leq \eta M$ then we bound by Stirling's bound $H(\tilde{U}_{(0)} | X_{[M_\rho]}, \tilde{Y}_{(0)}) \leq \eta M \log(\eta M) + O(M) = \eta M \log M + O(M)$.

The upper bound in (c) replaces the maximum of both cases ($M_\rho \leq \eta M$) by a sum.

We continue with the analysis of (B.144), and next turn to upper bound $H(\tilde{Y}^{LM})$. To this end, let $\bar{G}^M \in [M]$ be the following refinement of G^M . If $G_m = 0$ then $\bar{G}_m = 0$ too. Otherwise, if $G_m = 1$ then

$$\bar{G}_m = \min \left\{ \bar{m} : G_{\bar{m}} = 0, \Delta(\mathcal{P}(X_{\tilde{U}_{\bar{m}}}^L, X_{\tilde{U}_{\bar{m}}}^L), W^{\oplus d}) \leq \rho \right\}, \quad (\text{B.154})$$

that is \bar{G}_m , indicates which is the output cluster $\tilde{Y}_{\bar{G}_m}^L$ so that \tilde{Y}_m^L and $\tilde{Y}_{\bar{G}_m}^L$ are the outputs of “close” input molecules, where $\tilde{Y}_{\bar{G}_m}^L$ is the output of a molecule in the minimum-distance maximal set. In addition, let F_m be an arbitrary member of $\mathcal{P}_L(\mathcal{X} \times \mathcal{X})$ if $G_m = 0$ and $F_m = \mathcal{P}(X_{\tilde{U}_{\bar{G}_m}}^L, X_{\tilde{U}_{\bar{G}_m}}^L)$ if $G_m = 1$, that is, in case \tilde{Y}_m^L is not a cluster which is the result of sequencing a molecule in the maximal set, F_m indicates the joint type its input molecule and the “close” molecule in the maximal set. Note that $F_m \in \mathcal{P}_L(\mathcal{X} \times \mathcal{X})$. Then,

$$H(\tilde{Y}^{LM}) \leq H(\tilde{Y}^{LM}, \bar{G}^M, F^M) \quad (\text{B.155})$$

$$= H(\bar{G}^M, F^M) + H(\tilde{Y}^{LM} | \bar{G}^M, F^M) \quad (\text{B.156})$$

$$\leq O(M \log(\log M)) + (M - M_\rho) \log M + H(\tilde{Y}^{LM} | \bar{G}^M, F^M) \quad (\text{B.157})$$

where in the last inequality $H(\bar{G}^M, F^M)$ is bounded as follows: There are $\binom{M}{M_\rho} \leq 2^M$ ways to choose G^M , that is, the set of output clusters $\tilde{Y}_{(0)}$ which are the result of molecules in $X_{[M_\rho]}$. This can be specified with $O(M)$ nats. Then, for each of the $M - M_\rho$ indices in which $G_m = 1$, it requires $\log M_\rho$ nats to specify the cluster index \bar{m} , and

$$\log |\mathcal{P}_L(\mathcal{X} \times \mathcal{X})| \leq \log (L + 1)^{|\mathcal{X}|^2} = O(\log(\log M)) \quad (\text{B.158})$$

to specify the joint type (as follows from standard type counting, e.g., [11, Lemma 2.2]).

Continuing (B.157), we next bound $H(\tilde{Y}^{LM} | \bar{G}^M, F^M)$ as

$$\begin{aligned} & H(\tilde{Y}^{LM} | \bar{G}^M, F^M) \\ &= H(\tilde{Y}_{(0)} | \bar{G}^M, F^M) + H(\tilde{Y}_{(1)} | \tilde{Y}_{(0)}, \bar{G}^M, F^M) \end{aligned} \quad (\text{B.159})$$

$$\leq H(\tilde{Y}_{(0)} | \bar{G}^M) + H(\tilde{Y}_{(1)} | \tilde{Y}_{(0)}, \bar{G}^M, F^M) \quad (\text{B.160})$$

$$\stackrel{(a)}{\leq} \sum_{m \in [M]: G_m=0} H(\tilde{Y}_m^L) + \sum_{m \in [M]: G_m=1} H(\tilde{Y}_m^L | \tilde{Y}_{\bar{G}_m}^L, F_m) \quad (\text{B.161})$$

$$= \sum_{m \in [M]: G_m=0} H(\tilde{Y}_m^L) + \sum_{m \in [M]: G_m=1} H(\tilde{Y}_m^L | \tilde{Y}_{\bar{G}_m}^L, F_m) + H(\tilde{Y}_{\bar{G}_m}^L | F_m) - H(\tilde{Y}_{\bar{G}_m}^L | F_m) \quad (\text{B.162})$$

$$\stackrel{(b)}{=} \sum_{m \in [M]: G_m=0} H(\tilde{Y}_m^L) + \sum_{m \in [M]: G_m=1} H(\tilde{Y}_m^L, \tilde{Y}_{\bar{G}_m}^L | F_m) - H(\tilde{Y}_{\bar{G}_m}^L) \quad (\text{B.163})$$

where (a) follows from the standard independence bound on entropy bound $H(A, B) \leq H(A) + H(B)$ and since conditioning reduces entropy, and (b) follows since $\tilde{Y}_{\bar{G}_m}^L$ is independent of F_m [under \bar{P} defined in (B.139)]. Next, we combine this bound with the value of $H(\tilde{Y}^{LM} | X^{LM}, \tilde{U}^M)$ which is the last entropy term in the decomposition of $I(X^{LM}; \tilde{Y}^{LM})$ in (B.144). For this term, we simply write:

$$H(\tilde{Y}^{LM} | X^{LM}, \tilde{U}^M) = \sum_{m \in [M]} H(\tilde{Y}_m | X_{\tilde{U}_m}^L) \quad (\text{B.164})$$

$$= \sum_{m \in [M]: G_m=0} H(\tilde{Y}_m | X_{\tilde{U}_m}^L) + \sum_{m \in [M]: G_m=1} H(\tilde{Y}_m | X_{\tilde{U}_m}^L). \quad (\text{B.165})$$

Then, combining this expression with (B.163)

$$\begin{aligned} & H(\tilde{Y}^{LM} | \bar{G}^M, F^M) - H(\tilde{Y}^{LM} | X^{LM}, \tilde{U}^M) \\ &= \sum_{m \in [M]: G_m=0} H(\tilde{Y}_m^L) - H(\tilde{Y}_m^L | X_{\tilde{U}_m}^L) \\ &+ \sum_{m \in [M]: G_m=1} H(\tilde{Y}_m^L, \tilde{Y}_{\bar{G}_m}^L | F_m) - \sum_{m \in [M]: G_m=1} H(\tilde{Y}_m^L | X_{\tilde{U}_m}^L) - \sum_{m \in [M]: G_m=1} H(\tilde{Y}_{\bar{G}_m}^L | X_{\tilde{U}_{\bar{G}_m}}^L) \\ &- \sum_{m \in [M]: G_m=1} H(\tilde{Y}_{\bar{G}_m}^L) + \sum_{m \in [M]: G_m=1} H(\tilde{Y}_{\bar{G}_m}^L | X_{\tilde{U}_{\bar{G}_m}}^L) \end{aligned} \quad (\text{B.166})$$

$$= \sum_{m \in [M]: G_m=0} I(X_{\tilde{U}_m}^L; \tilde{Y}_m^L) + \sum_{m \in [M]: G_m=1} I(X_{\tilde{U}_m}^L, X_{\tilde{U}_{\bar{G}_m}}^L; \tilde{Y}_m^L, \tilde{Y}_{\bar{G}_m}^L | F_m) - I(X_{\tilde{U}_{\bar{G}_m}}^L; \tilde{Y}_{\bar{G}_m}^L) \quad (\text{B.167})$$

$$\stackrel{(a)}{=} (2M_\rho - M) \cdot L \cdot I(P_X, W^{\oplus d}) + o(ML) + \sum_{m \in [M]: G_m=1} I(X_{\tilde{U}_m}^L, X_{\tilde{U}_{\bar{G}_m}}^L; \tilde{Y}_m^L, \tilde{Y}_{\bar{G}_m}^L | F_m) \quad (\text{B.168})$$

$$\stackrel{(b)}{\leq} (2M_\rho - M) \cdot L \cdot I(P_X, W^{\oplus d}) + 2(M - M_\rho)L \cdot I(P_X, W^{\oplus d}) - L(M - M_\rho) \cdot \text{CID}(P_X, W^{\oplus d}) + o(ML) \quad (\text{B.169})$$

$$= ML \cdot I(P_X, W^{\oplus d}) - L(M - M_\rho) \cdot \text{CID}(P_X, W^{\oplus d}) + o(ML), \quad (\text{B.170})$$

where:

- (a) holds since under the assumed input distribution to the channel \bar{P} it holds that $X_m^L \sim \text{Uniform}[\mathcal{T}_L(P_X)]$, and by Lemma 41 from Appendix C-C the mutual information in this case is $L \cdot I(P_X, W^{\oplus d}) + o(L)$ (where $I(P_X, W^{\oplus d})$ is the single-letter mutual information in the DMC $W^{\oplus d}$ with input distribution P_X).
- (b) follows from Prop. 27, where here we utilized the fact that conditioned on F_m , the input distribution is supported on the type indicated by F_m with probability 1, say $Q_{X\bar{X}}$, and this joint type satisfies $\Delta(Q_{X\bar{X}}, W^{\oplus d}) \leq \rho \equiv \rho_L = o(L)$.

Combining (B.170) with (B.157) we obtain the bound

$$H(\tilde{Y}^{LM}) - H(\tilde{Y}^{LM} | X^{LM}, \tilde{U}^M) \leq ML \cdot I(P_X, W^{\oplus d}) - L(M - M_\rho) \cdot \text{CID}(P_X, W^{\oplus d}) + (M - M_\rho) \log M + o(ML). \quad (\text{B.171})$$

Further combining the bounds (B.152) and (B.171) on the entropy terms in (B.144) and setting, $L = \beta \log M$ we obtain

$$I(X^{LM}; \tilde{Y}^{LM}) \leq ML \left[I(P_X, W^{\oplus d}) - \left(1 - \frac{M_\rho}{M}\right) \text{CID}(P_X, W^{\oplus d}) + \left(1 - \frac{2M_\rho}{M}\right) \frac{1}{\beta} + \frac{\eta}{\beta} + o(1) \right]. \quad (\text{B.172})$$

Since M_ρ is arbitrary, a general bound must take the worst case over $M_\rho \in [M]$. The term in the last bound which depends on M_ρ is given by

$$\frac{M_\rho}{M} \left[\text{CID}(P_X, W^{\oplus d}) - \frac{2}{\beta} \right] \quad (\text{B.173})$$

and if $\text{CID}(P_X, W^{\oplus d}) \geq \frac{2}{\beta}$ then this term is maximized by $M_\rho = M$ and otherwise by $M_\rho = 0$. Inserting this into (B.172), and taking $\eta \downarrow 0$ we obtain

$$\frac{I(X^{LM}; \tilde{Y}^{LM})}{ML} \leq \begin{cases} I(P_X, W^{\oplus d}) - \frac{1}{\beta} + o(1), & \text{CID}(P_X, W^{\oplus d}) \geq \frac{2}{\beta} \\ I(P_X, W^{\oplus d}) - \text{CID}(P_X, W^{\oplus d}) + \frac{1}{\beta} + o(1) & \text{CID}(P_X, W^{\oplus d}) < \frac{2}{\beta} \end{cases}. \quad (\text{B.174})$$

The second case above will be used when $\text{CID}(P_X, W^{\oplus d}) > \frac{1}{\beta}$. Otherwise, the trivial bound $I(X^{LM}; \tilde{Y}^{LM}) \leq ML \cdot I(P_X \times W^{\oplus d})$ – which can be easily obtained by analyzing a decoder which knows the molecule order \tilde{U}^M – is better. Summarizing all three cases and utilizing the definition of $J_d(P_X, W, \beta)$ in (B.1) completes the proof. \blacksquare

We can now prove Prop. 30:

Proof of Prop. 30: To simplify the notation we again use M instead of $\theta_M M$. Recall the molecule duplicate vector S^M where S_m is the number of times that molecule X_m^L have been sampled, and that $Q^{N+1} = \mathcal{N}(S^M)$.

Then,

$$\begin{aligned} & I(X^{LM}; \tilde{Y}^{LM} | Q^{N+1} = q^{N+1}) \\ & \leq I(X^{LM}; \tilde{Y}^{LM}, S^M | Q^{N+1} = q^{N+1}) \end{aligned} \quad (\text{B.175})$$

$$= I(X^{LM}; S^M | Q^{N+1} = q^{N+1}) + I(X^{LM}; \tilde{Y}^{LM} | S^M, Q^{N+1} = q^{N+1}) \quad (\text{B.176})$$

$$= I(X^{LM}; \tilde{Y}^{LM} | S^M, Q^{N+1} = q^{N+1}) \quad (\text{B.177})$$

where the right-most equality follows since X^{LM} and S^M are independent given Q^{N+1} and so $I(X^{LM}; S^M | Q^{N+1} = q^{N+1}) = 0$. We next bound the last mutual information for an arbitrary s^M for which $\mathcal{N}(s^M) = q^{N+1}$.

Let $\mathcal{M}_d := \{m \in [M]: s_m = d\}$ denote the set of molecule indices which have been sampled d times (where

$|\mathcal{M}_d|=q_d$). Conditioned on $S^M = s^M$ (in essence, assuming that the decoder knows $S^M = s^M$), the decoder can partition any codeword X^{LM} to sets $X_{\mathcal{M}_d} = (X_m^L)_{m \in \mathcal{M}_d}$ for $d \in [N+1]$, and, in accordance, partition the entire codebook \mathcal{C}_M to shorter codebooks $\mathcal{C}_{\mathcal{M}_d}$. Since the number of L -tuples in \tilde{Y}_m^L is trivially known to the decoder, it knows $\overline{\mathcal{M}}_d := \{m \in [M]: \tilde{Y}_m^L \in (\mathcal{Y}^d)^L\}$ and so it can similarly partition \tilde{Y}_m^L to the corresponding sets $\tilde{Y}_{\overline{\mathcal{M}}_d}$ so that the q_d clusters in $\tilde{Y}_{\overline{\mathcal{M}}_d}$ are the result of sequencing $X_{\mathcal{M}_d}$ in a random order (uniform over all permutations). Then,

$$I(X^{LM}; \tilde{Y}^{LM} | S^M = s^M) = I\left(X_{\mathcal{M}_0}, X_{\mathcal{M}_1}, \dots, X_{\mathcal{M}_N}; \tilde{Y}_{\overline{\mathcal{M}}_0}, \dots, \tilde{Y}_{\overline{\mathcal{M}}_N} | S^M = s^M\right) \quad (\text{B.178})$$

$$\stackrel{(a)}{=} H\left(\tilde{Y}_{\overline{\mathcal{M}}_0}, \dots, \tilde{Y}_{\overline{\mathcal{M}}_N} | S^M = s^M\right) - \sum_{d \in [N+1]} H\left(\tilde{Y}_{\overline{\mathcal{M}}_d} | X_{\mathcal{M}_d}, S^M = s^M\right) \quad (\text{B.179})$$

$$\stackrel{(b)}{\leq} \sum_{d \in [N+1]} H\left(\tilde{Y}_{\overline{\mathcal{M}}_d}\right) - \sum_{d \in [N+1]} H\left(\tilde{Y}_{\overline{\mathcal{M}}_d} | X_{\mathcal{M}_d}\right) \quad (\text{B.180})$$

$$= \sum_{d \in [N+1]} I(X_{\mathcal{M}_d}; \tilde{Y}_{\overline{\mathcal{M}}_d}) \quad (\text{B.181})$$

where (a) follows since conditioned on $X_{\mathcal{M}_d}$, $\tilde{Y}_{\overline{\mathcal{M}}_d}$ is independent of all other variables, and (b) follows from the standard independence bound on entropy bound $H(A, B) \leq H(A) + H(B)$, and since conditioning reduces entropy. Each mutual information term $I(X_{\mathcal{M}_d}; \tilde{Y}_{\overline{\mathcal{M}}_d})$ in the sum (B.181) corresponds to a channel $x_{\mathcal{M}_d} \rightarrow \tilde{y}_{\mathcal{M}_d}$ in which each molecule is sampled exactly d times, and so Lemma 31 can be utilized. Specifically, first, for $d = 0$ (the erased molecules) $I(x_{\mathcal{M}_0}; \tilde{y}_{\mathcal{M}_0}) = 0$. Second, for any $d \geq \bar{d}$ (molecules which are ‘‘over-sampled’’) we bound

$$\sum_{d \in [N+1] \setminus [\bar{d}]} I(X_{\mathcal{M}_d}; \tilde{Y}_{\overline{\mathcal{M}}_d}) \leq \sum_{d \in [N+1] \setminus [\bar{d}]} H(x_{\mathcal{M}_d}) \leq \left(M - \sum_{d \in [\bar{d}]} q_d\right) L \log |\mathcal{X}|. \quad (\text{B.182})$$

Third, for $d \in [\bar{d}]$ with $d > 0$ we have two sub-cases. Let $\underline{\theta} > 0$ be arbitrary.

- If $q_d \leq \underline{\theta}M$ then we bound,

$$I(X_{\mathcal{M}_d}; \tilde{Y}_{\overline{\mathcal{M}}_d}) \leq \underline{\theta}ML \log |\mathcal{X}| \quad (\text{B.183})$$

- If $q_d > \underline{\theta}M$ then we use Lemma 31, which can be succinctly written as

$$I(X_{\mathcal{M}_d}; \tilde{Y}_{\overline{\mathcal{M}}_d}) \leq q_d \cdot \left\{ I_{P_X \times W^{\oplus d}}(X; Y) - \left[\text{CID}(P_X, W^{\oplus d}) - \frac{1}{\beta} \right]_+ + \left[\text{CID}(P_X, W^{\oplus d}) - \frac{2}{\beta} \right]_+ + o(1) \right\}. \quad (\text{B.184})$$

Note that $\underline{\theta}M$ is fixed, and so Lemma 31 holds even if M is replaced with $\theta_M M$.

Summing up all mutual information bounds for all d and substituting in (B.181), and then taking $\underline{\theta} \downarrow 0$ and using the definition of $J_d(P_X, W, \beta)$ in (B.1) establishes the claimed bound. \blacksquare

2) *Fixed Composition Molecules and Random Q^{N+1}* : In this section, we remove the conditioning on a given amplification vector $Q^{N+1} = q^{N+1}$, and prove an upper bound on the average mutual information for a random Q^{N+1} .

Proposition 32. *Consider the same assumptions as in Prop. 30. Then,*

$$\frac{1}{ML} I(X^{LM}; \tilde{Y}^{LM} | Q^{N+1}) \leq \sum_{d \in \mathbb{N}} \pi_\alpha(d) \cdot J_d(P_X, W, \beta) + o(1) \quad (\text{B.185})$$

where $J_d(P_X, W, \beta)$ is as defined in (B.1), and $\pi_\alpha(d) := \frac{\alpha^d e^{-\alpha}}{d!}$ Poisson p.m.f. with parameter α .

To prove this proposition, we will need a notion of a typical set for amplification vectors, defined as follows:

$$\mathcal{A}_{\bar{d}}(\chi) := \left\{ q^{N+1} \in \mathcal{Q}(M, N) : \max_{d \in [\bar{d}]} \left| \frac{q_d}{M} - \pi_\alpha(d) \right| \leq \chi \right\} \quad (\text{B.186})$$

and the next lemma which estimates the tolerance χ required for $\mathcal{A}_{\bar{d}}(\chi)$ to have probability ψ .

Lemma 33 (Typical sampling set). *Let $\bar{d} \in [N + 1]$ be given, let $S^M \sim \text{Multinomial}(N, (\frac{1}{M}, \dots, \frac{1}{M}))$, let $Q^{N+1} = \mathcal{N}(S^M)$ be its empirical distribution, and let $\chi(\psi)$ satisfy*

$$\mathbb{P} [Q^{N+1} \in \mathcal{A}_{\bar{d}}(\chi(\psi))] = \psi. \quad (\text{B.187})$$

Then, $\chi(\psi) = O_{\bar{d}, \psi}(\frac{1}{\sqrt{M}})$.

Proof: By the union bound

$$\mathbb{P} [Q^{N+1} \in \mathcal{A}_{\bar{d}}^c(\chi)] \leq \bar{d} \cdot \mathbb{P} \left[\left| \frac{Q_d}{M} - \pi_\alpha(d) \right| > \chi \right]. \quad (\text{B.188})$$

Recall that $\frac{Q_d}{M}$ is the average of M indicator random variables

$$\frac{Q_d}{M} = \frac{1}{M} \sum_{m \in [M]} \mathbb{1}\{S_m = d\}, \quad (\text{B.189})$$

and while these variables are not statistically independent, as we shall next show, the correlation between them is low, and so the probability of the deviation of $\frac{Q_d}{M}$ from its mean can be bounded by Chebyshev's inequality.

The mean is $\mathbb{E}[Q_d/M] = \mathbb{P}[S_m = d]$, and the second moment is

$$\mathbb{E} \left[\left(\frac{Q_d}{M} \right)^2 \right] = \frac{1}{M^2} \sum_{m \in [M]} \sum_{m' \in [M]} \mathbb{P}[\{S_m = d\} \cap \{S_{m'} = d\}] \quad (\text{B.190})$$

$$= \frac{\mathbb{P}[S_0 = d]}{M} + \frac{1}{M^2} \sum_{m, m' \in [M]: m' \neq m} \mathbb{P}[\{S_m = d\} \cap \{S_{m'} = d\}] \quad (\text{B.191})$$

$$= \frac{\mathbb{P}[S_0 = d]}{M} + \frac{M^2 - M}{M^2} \cdot \mathbb{P}[\{S_m = d\} \cap \{S_{m'} = d\}]. \quad (\text{B.192})$$

Now, for $m' \neq m$ it holds that $S_m \sim \text{Binomial}(N, \frac{1}{M})$ and $S_{m'} | S_m = d \sim \text{Binomial}(N - d, \frac{1}{M-1})$.²⁸ So,

$$\mathbb{P}[S_m = d] = \binom{N}{d} \left(\frac{1}{M}\right)^d \left(1 - \frac{1}{M}\right)^{N-d} \quad (\text{B.193})$$

and

$$\mathbb{P}[S_{m'} = d | S_m = d] = \binom{N-d}{d} \left(\frac{1}{M-1}\right)^d \left(1 - \frac{1}{M-1}\right)^{N-2d}. \quad (\text{B.194})$$

So, as long as $d \in [\bar{d}]$ and $\bar{d} = \Theta(1)$

$$\frac{\mathbb{P}[S_{m'} = d | S_m = d]}{\mathbb{P}[S_m = d]} = \frac{\binom{N-d}{d} \left(\frac{M-1}{M-2}\right)^{2d} \left(\frac{M(M-2)}{(M-1)^2}\right)^N}{\binom{N}{d}} \quad (\text{B.195})$$

$$\stackrel{(a)}{\leq} \frac{\binom{N-d}{d} \left(\frac{M-1}{M-2}\right)^{2d}}{\binom{N}{d}} \quad (\text{B.196})$$

$$= \frac{[(N-d)!]^2}{(N-2d)! N!} \left(\frac{M-1}{M-2}\right)^{2d} \quad (\text{B.197})$$

$$= \frac{(N-d) \cdots (N-2d+1)}{N(N-1) \cdots (N-d+1)} \left(\frac{M-1}{M-2}\right)^{2d} \quad (\text{B.198})$$

$$= \left(1 - \frac{d}{N}\right) \left(1 - \frac{d}{N-1}\right) \cdots \left(1 - \frac{d}{N-d+1}\right) \left(1 + \frac{1}{M-2}\right)^{2d} \quad (\text{B.199})$$

$$\stackrel{(b)}{=} 1 + O_{\bar{d}}\left(\frac{1}{M}\right) \quad (\text{B.200})$$

where (a) follows since $M(M-2)/(M-1)^2 \leq 1$, and (b) follows since $d \in [\bar{d}]$. So,

$$\mathbb{P}[\{S_m = d\} \cap \{S_{m'} = d\}] = \mathbb{P}[S_m = d] \mathbb{P}[S_{m'} = d | S_m = d] \quad (\text{B.201})$$

$$\leq \mathbb{P}^2[S_m = d] \left(1 + O_{\bar{d}}\left(\frac{1}{M}\right)\right). \quad (\text{B.202})$$

Hence, from (B.192)

$$\mathbb{E} \left[\left(\frac{Q_d}{M}\right)^2 \right] \leq \frac{\mathbb{P}[S_0 = d]}{M} + \frac{M^2 - M}{M^2} \cdot \mathbb{P}^2[S_m = d] \left(1 + O_{\bar{d}}\left(\frac{1}{M}\right)\right) \quad (\text{B.203})$$

$$\leq \frac{1}{M} + \mathbb{P}^2[S_m = d] \left(1 + O_{\bar{d}}\left(\frac{1}{M}\right)\right) \quad (\text{B.204})$$

$$= \mathbb{P}^2[S_m = d] + O_{\bar{d}}\left(\frac{1}{M}\right) \quad (\text{B.205})$$

and then

$$\mathbb{V} \left[\frac{Q_d}{M} \right] = \mathbb{E} \left[\left(\frac{Q_d}{M}\right)^2 \right] - \mathbb{E}^2 \left[\frac{Q_d}{M} \right] = O_{\bar{d}}\left(\frac{1}{M}\right). \quad (\text{B.206})$$

²⁸This is because $U^N \sim \text{Uniform}[M] \setminus \{m\}$ for in the indices $n \in [N]$ for which $U_n \neq m$.

We thus denote $\mathbb{V} \left[\frac{Q_d}{M} \right] := \frac{c_{\bar{d}}}{M}$ where $c_{\bar{d}}$ depends only on \bar{d} . By Chebyshev's inequality

$$\mathbb{P} \left[\left| \frac{Q_d}{M} - \mathbb{E} \left[\frac{Q_d}{M} \right] \right| > \chi \right] = \mathbb{P} \left[\left| \frac{Q_d}{M} - \mathbb{P}[S_m = d] \right| > \chi \right] \leq \frac{c_{\bar{d}}}{M\chi^2} \quad (\text{B.207})$$

and by the union bound

$$\mathbb{P} \left[\max_{d \in [\bar{d}]} \left| \frac{Q_d}{M} - \mathbb{P}[S_m = d] \right| > \chi \right] \leq \frac{\bar{d}c_{\bar{d}}}{M\chi^2}. \quad (\text{B.208})$$

Let $\tilde{S}_0 \sim \text{Pois}(\alpha)$. Since $S_m \sim \text{Binomial}(N, \frac{1}{M})$ and $N \cdot \frac{1}{M} = \alpha$, a constant, the binomial distribution tends to a Poisson distribution. The approximation error is due to Hodges and Le-Cam (e.g., [13, Sec. 3.6.1])

$$\left| \mathbb{P}[S_0 = d] - \mathbb{P}[\tilde{S}_0 = d] \right| \leq \frac{N}{M^2} = \frac{\alpha}{M}. \quad (\text{B.209})$$

Since $\mathbb{P}[\tilde{S}_0 = d] = \pi_\alpha(d)$ (by definition)

$$\begin{aligned} & \mathbb{P} \left[\max_{d \in [\bar{d}]} \left| \frac{Q_d}{M} - \pi_\alpha(d) \right| > \chi \right] \\ &= \mathbb{P} \left[\max_{d \in [\bar{d}]} \left| \frac{Q_d}{M} - \mathbb{P}[S_0 = d] + \mathbb{P}[S_0 = d] - \mathbb{P}[\tilde{S}_0 = d] \right| > \chi \right] \end{aligned} \quad (\text{B.210})$$

$$\leq \mathbb{P} \left[\max_{d \in [\bar{d}]} \left| \frac{Q_d}{M} - \mathbb{P}[S_0 = d] \right| + \left| \mathbb{P}[S_0 = d] - \mathbb{P}[\tilde{S}_0 = d] \right| > \chi \right] \quad (\text{B.211})$$

$$\leq \mathbb{P} \left[\max_{d \in [\bar{d}]} \left| \frac{Q_d}{M} - \mathbb{P}[S_0 = d] \right| + \left| \mathbb{P}[S_0 = d] - \mathbb{P}[\tilde{S}_0 = d] \right| > \chi - \frac{\alpha}{M} \right] \quad (\text{B.212})$$

$$\leq \frac{\bar{d}c_{\bar{d}}}{M \left(\chi - \frac{\alpha}{M} \right)^2} \quad (\text{B.213})$$

Thus for $\mathbb{P}[Q^{N+1} \in \mathcal{A}_{\bar{d}}(\chi(\psi))] \geq \psi$ it suffices to require $\chi = \frac{\alpha}{M} + \sqrt{\frac{\bar{d}c_{\bar{d}}}{\psi M}} = O_{\bar{d}, \psi}(\frac{1}{\sqrt{M}})$. \blacksquare

We are now ready to prove an upper bound on the mutual information for random Q^{N+1} .

Proof of Prop. 32: We again use M instead of $\bar{M} = \theta_M M$ to lighten notation. The next proof holds verbatim for any $\theta_M = \frac{1}{M^{\circ(1)}}$.

Let arbitrary $\psi \in (0, 1)$ and $\eta > 0$ be given, and choose \bar{d} such that $\sum_{d \in [\bar{d}]} \pi_\alpha(d) \geq 1 - \eta$ (which is always possible since $\sum_{d \in \mathbb{N}} \pi_\alpha(d) = 1$, $\pi_\alpha(d) \geq 0$). Then,

$$\begin{aligned} I(X^{LM}; \tilde{Y}^{LM} | Q^{N+1}) &= \mathbb{P}[Q^{N+1} \in \mathcal{A}_{\bar{d}}(\chi(\psi))] \cdot I(X^{LM}; \tilde{Y}^{LM} | Q^{N+1} \in \mathcal{A}_{\bar{d}}(\chi(\psi))) \\ &\quad + \mathbb{P}[Q^{N+1} \in \mathcal{A}_{\bar{d}}^c(\chi(\psi))] \cdot I(X^{LM}; \tilde{Y}^{LM} | Q^{N+1} \in \mathcal{A}_{\bar{d}}^c(\chi(\psi))) \end{aligned} \quad (\text{B.214})$$

$$\leq I(X^{LM}; \tilde{Y}^{LM} | Q^{N+1} \in \mathcal{A}_{\bar{d}}(\chi(\psi))) + (1 - \psi)ML \log |\mathcal{X}| \quad (\text{B.215})$$

since it holds for any $q^{N+1} \in \mathcal{Q}(M, N)$ that

$$I(X^{LM}; \tilde{Y}^{LM} | Q^{N+1} = q^{N+1}) \leq H(X^{LM}) \leq ML \log |\mathcal{X}|. \quad (\text{B.216})$$

We next bound $I(X^{LM}; \tilde{Y}^{LM} | Q^{N+1})$ for an arbitrary $q^{N+1} \in \mathcal{A}_{\bar{d}}(\chi(\psi))$. By Lemma 33, for any $q^{N+1} \in \mathcal{A}_{\bar{d}}(\chi(\psi))$ it holds

$$\left| \frac{q_d}{M} - \pi_\alpha(d) \right| \leq O_{\bar{d}, \psi} \left(\frac{1}{\sqrt{M}} \right) \quad (\text{B.217})$$

for all $d \in [\bar{d}]$. Thus, $\frac{q_d}{M} \leq \pi_\alpha(d) + O_{\bar{d}, \psi} \left(\frac{1}{\sqrt{M}} \right)$ for $d \in [\bar{d}]$ and also

$$1 - \sum_{d \in [\bar{d}]} \frac{q_d}{M} \leq 1 - \sum_{d \in [\bar{d}]} \pi_\alpha(d) + O_{\bar{d}, \psi} \left(\frac{1}{\sqrt{M}} \right) \leq \eta + O_{\bar{d}, \psi} \left(\frac{1}{\sqrt{M}} \right). \quad (\text{B.218})$$

So Prop. 30 implies that

$$I(X^{LM}; \tilde{Y}^{LM} | Q^{N+1} = q^{N+1}) \leq \sum_{d \in [\bar{d}]} \pi_\alpha(d) \cdot J_d(P_X, W, \beta) + \eta \cdot \log |\mathcal{X}| + o_{\bar{d}, |\mathcal{X}|, \alpha}(1) \quad (\text{B.219})$$

where $J_d(P_X, W, \beta)$ is as defined in (B.1). Taking $M \rightarrow \infty$ and then accordingly $\bar{d} \uparrow \infty$, and $\eta \downarrow 0$, $\psi \uparrow 1$, proves the claim of the proposition. \blacksquare

3) *General Composition Molecules* : In the previous section, we have bounded the mutual information between the input X^{LM} and the output \tilde{Y}^{LM} , conditioned on Q^{N+1} , and assuming that the input molecules all have the same fixed composition. In this section, we remove the fixed composition assumption.

Proposition 34. *Assume that the sequencing channel is such that $\nu_{\min}(W) < \infty$. Then,*

$$\frac{1}{ML} I(X^{LM}; \tilde{Y}^{LM}) \leq \max_{P_X} \sum_{d \in \mathbb{N}} \pi_\alpha(d) \cdot J_d(P_X, W, \beta) + o(1) \quad (\text{B.220})$$

where $J_d(P_X, W, \beta)$ is as defined in (B.1), and $\pi_\alpha(d) := \frac{\alpha^d e^{-\alpha}}{d!}$ Poisson p.m.f. with parameter α .

Proof: By Prop. 29, it can be assumed that there exists $\{P_{X,m}\}_{m \in [M]} \subseteq \mathcal{P}_L(\mathcal{X})$ (with $L = \beta \log M$) such that $\mathcal{P}(x_m(j)) = P_{X,m}$ for all $j \in [|\mathcal{C}_M|]$. That is, the composition is fixed for each molecule index $m \in [M]$ over all codewords, but may change from one index to the another. Let $T^M \in [|\mathcal{P}_L(\mathcal{X})|]^M$ be such that $T_m = \mathcal{P}(x_{\tilde{U}_m}(j))$, that is T_m states the molecule type $P_X \in \mathcal{P}_L(\mathcal{X})$ from which the outputs in \tilde{Y}_m^L were sequenced.

We bound the mutual information as follows:

$$I(X^{LM}; \tilde{Y}^{LM}) \leq I(X^{LM}; \tilde{Y}^{LM}, T^M) \quad (\text{B.221})$$

$$= I(X^{LM}; T^M) + I(X^{LM}; \tilde{Y}^{LM} | T^M) \quad (\text{B.222})$$

$$\leq H(T^M) + I(X^{LM}; \tilde{Y}^{LM} | T^M) \quad (\text{B.223})$$

$$= o(ML) + I(X^{LM}; \tilde{Y}^{LM} | T^M) \quad (\text{B.224})$$

where the last equality follows since $|\mathcal{P}_L(\mathcal{X})| \leq (L+1)^{|\mathcal{X}|}$ and so

$$H(T^M) \leq \sum_{m \in [M]} H(T_m) \leq M \log \left[(L+1)^{|\mathcal{X}|} \right] = O(M \log(\log M)) = o(ML). \quad (\text{B.225})$$

We continue by bounding $I(X^{LM}; \tilde{Y}^{LM} | T^M)$. Recall that in the proof of Prop. 30, the assumption that the decoder knows S^M allowed it to partition X^{LM} to subsets of molecules $X_{\mathcal{M}_d}$ which have been sampled d times (therein, we have used $\mathcal{M}_d = \{m \in [M]: S_m = d\}$), and to couple them with the set of output clusters which contain d molecules, namely $\tilde{Y}_{\overline{\mathcal{M}}_d}$. Then the mutual information was upper bounded by $\sum_d I(X_{\overline{\mathcal{M}}_d}; \tilde{Y}_{\overline{\mathcal{M}}_d})$. The same strategy is taken here only with the molecule type replaces the number of samples d . To this end, let $\overline{\mathcal{M}}_{P_X} = \{m \in [M]: \mathcal{P}(X_{\tilde{U}_m}^L) = P_X\}$ where we recall that \tilde{U}_m is such that $\tilde{Y}_m^L = Z_{\tilde{U}_m}^L = \{Y_n^L: U_n = m\}$. We then partition \tilde{Y} to sub-vectors $Y_{\overline{\mathcal{M}}_{P_X}} = (Y_m^L)_{m \in \overline{\mathcal{M}}_{P_X}}$ for $P_X \in \mathcal{P}_L(\mathcal{X})$. In addition, we set $X_{\mathcal{M}_{P_X}}$ to be the set of X_m^L such that $\mathcal{P}(X_m^L) = P_X$ (by the structural assumption on the codebook the indices of this set are the same for all codewords, and thus known to the decoder). Then, as in (B.181)

$$I(X^{LM}; \tilde{Y}^{LM} | T^M) \leq \sum_{P_X \in \mathcal{P}_L(\mathcal{X})} I(X_{\mathcal{M}_{P_X}}; \tilde{Y}_{\overline{\mathcal{M}}_{P_X}}). \quad (\text{B.226})$$

Let $\eta > 0$ be given, and denote for brevity $\omega_L = |\mathcal{P}_L(\mathcal{X})|$ and $M_{P_X} = |\mathcal{M}_{P_X}|$. We then split the possible types $\mathcal{P}_L(\mathcal{X})$ to those with $\frac{M_{P_X}}{M} < \frac{\eta}{\omega_L}$ and their complement, and bound as in (B.226)

$$I(X^{LM}; \tilde{Y}^{LM} | T^M) \leq \sum_{P_X \in \mathcal{P}_L(\mathcal{X}): \frac{M_{P_X}}{M} < \frac{\eta}{\omega_L}} I(X_{\mathcal{M}_{P_X}}; \tilde{Y}_{\overline{\mathcal{M}}_{P_X}}) + \sum_{P_X \in \mathcal{P}_L(\mathcal{X}): \frac{M_{P_X}}{M} \geq \frac{\eta}{\omega_L}} I(X_{\mathcal{M}_{P_X}}; \tilde{Y}_{\overline{\mathcal{M}}_{P_X}}) \quad (\text{B.227})$$

$$\leq \eta ML \log |\mathcal{X}| + \sum_{P_X \in \mathcal{P}_L(\mathcal{X}): \frac{M_{P_X}}{M} \geq \frac{\eta}{\omega_L}} I(X_{\mathcal{M}_{P_X}}; \tilde{Y}_{\overline{\mathcal{M}}_{P_X}}) \quad (\text{B.228})$$

where the inequality follows from the (generous) bound $I(X_{\mathcal{M}_{P_X}}; \tilde{Y}_{\overline{\mathcal{M}}_{P_X}}) \leq M_{P_X} L \log |\mathcal{X}|$ and since the number of total terms in both sums is ω_L . We continue by bounding $I(X_{\mathcal{M}_{P_X}}; \tilde{Y}_{\overline{\mathcal{M}}_{P_X}})$ for the case $\frac{M_{P_X}}{M} \geq \frac{\eta}{\omega_L}$. Let Q_{P_X} be the restriction of the amplification vector Q^{N+1} to the molecules which have type P_X . Then,

$$I(X_{\mathcal{M}_{P_X}}; \tilde{Y}_{\overline{\mathcal{M}}_{P_X}}) \leq I(X_{\mathcal{M}_{P_X}}; \tilde{Y}_{\overline{\mathcal{M}}_{P_X}}, Q_{P_X}) \quad (\text{B.229})$$

$$= I(X_{\mathcal{M}_{P_X}}; Q_{P_X}) + I(X_{\mathcal{M}_{P_X}}; \tilde{Y}_{\overline{\mathcal{M}}_{P_X}} | Q_{P_X}) \quad (\text{B.230})$$

$$\stackrel{(a)}{=} I(X_{\mathcal{M}_{P_X}}; \tilde{Y}_{\overline{\mathcal{M}}_{P_X}} | Q_{P_X}) \quad (\text{B.231})$$

$$\stackrel{(b)}{\leq} M_{P_X} L \sum_{d \in \mathbb{N}} \pi_\alpha(d) \cdot J_d(P_X, W, \beta) + o(ML) \quad (\text{B.232})$$

$$\leq M_{P_X} L \cdot \max_{P_X \in \mathcal{P}(\mathcal{X})} \sum_{d \in \mathbb{N}} \pi_\alpha(d) \cdot J_d(P_X, W, \beta) + o(ML) \quad (\text{B.233})$$

where (a) follows since $X_{\mathcal{M}_{P_X}}$ and Q_{P_X} are independent, and (b) follows from Prop. 32, yet requires the following justification: Prop. (32) requires that the codewords have $\theta_M M$ molecules, each of length $L = \beta \log M$.

Here, we apply this proposition to the case in which there are $M_{P_X} \geq \frac{\eta M}{\omega_L} \geq \frac{\eta M}{(L+1)^{|\mathcal{X}|}} = \Theta\left(\frac{M}{\log^{|\mathcal{X}|} M}\right)$ and so $\theta = \Theta\left(\frac{1}{\log^{|\mathcal{X}|} M}\right)$ which decreases sub-polynomially, as required. It should be emphasized, that that the asymptotic terms in Lemma 24 – which the proof Prop. (32) hinges on – do not depend on the input distribution of the molecules P_X .

Inserting the bounds (B.233) into (B.228) and then to (B.224), and taking $\eta \downarrow 0$ leads to the claim. ■

APPENDIX C

AUXILIARY RESULTS AND PROOFS

A. Symmetry of Binomial Extensions of Symmetric DMCs

In this section, we explore when symmetry of a DMC $V: \mathcal{A} \rightarrow \mathcal{B}$ is preserved for its binomial extensions $V^{\oplus d}: \mathcal{A} \rightarrow \mathcal{B}^d$ (Definition 4). To this end, it will be convenient to identify a DMC $V: \mathcal{A} \rightarrow \mathcal{B}$ with a matrix of $|\mathcal{A}|$ rows (for input letters) and $|\mathcal{B}|$ columns (for output letters). Thus, the a th row of V contains the values of $V(\cdot | a)$, and so sums to 1. We will denote the sub-matrix of V of dimension $|\mathcal{A}| \times |\mathcal{B}_0|$ comprised of the columns pertaining to \mathcal{B}_0 by $V_{|\mathcal{B}_0}$. We begin with the following definition:

Definition 35. A matrix U is said to be *doubly-permutation* if each row of U is a permutation of each other row, and each column of U (if more than 1) is a permutation of each other column.

We recall the definition of a symmetric channel, in a strong sense, and in Gallager’s sense.

Definition 36. A DMC $V: \mathcal{A} \rightarrow \mathcal{B}$ is said to be *symmetric* if its channel matrix is doubly-permutation. A DMC $V: \mathcal{A} \rightarrow \mathcal{B}$ is said to be *symmetric in Gallager’s sense* [16, p. 94] if there exists a (disjoint) partition of $\mathcal{B} = \bigcup_i \mathcal{B}_i$ such that $V_{|\mathcal{B}_i}$ is doubly-permutation for all i . A DMC is called *modulo-additive* if $\mathcal{A} = \mathcal{B}$ and the rows of V are cyclic shifts of one another.

As discussed in Sec. V, modulo-additive channels are obtained by the relation $B = A \oplus C$ where C is independent of the input A and \oplus is addition modulo $|\mathcal{A}|$ [see (35)].

In this appendix we establish two results regarding the symmetry of $V^{\oplus d}$. First, we consider the special case of modulo-additive channels, and show:

Proposition 37. *Let $V: \mathcal{A} \rightarrow \mathcal{B}$ be a modulo-additive DMC. Then $V^{\oplus d}$ is symmetric in Gallager’s sense for all $d \in \mathbb{N}^+$.*

For general symmetric channels, symmetry does not always hold for $V^{\oplus d}$ (see counterexamples at the end of this section). Nonetheless, we prove that, specifically, for DMCs with 4 letter input and output alphabets, which are especially relevant for the DNA channel, such symmetry does hold:

Proposition 38. *Let $V: \mathcal{A} \rightarrow \mathcal{B}$ be a DMC and let $V^{\oplus d}$ be its d -order binomial extension. Assume that $|\mathcal{A}| \leq 4$ and that $|\mathcal{B}| \leq |\mathcal{A}|$. If V is symmetric in Gallager’s sense then so is $V^{\oplus d}$ for all $d \in \mathbb{N}^+$.*

We begin with the proof of Prop. 37.

Proof of Prop. 37: Assume w.l.o.g. that $\mathcal{A} = [A]$ where $A = |\mathcal{A}|$, and let an arbitrary $d \in \mathbb{N}^+$ be given. We will partition the output letters of $\mathcal{B}^d = [A]^d$ to subsets $\{\mathcal{B}_i^d\}$ such that $V_{|\mathcal{B}_i^d}$ is doubly-permutation for all i . Let $(a_0, \dots, a_{d-1}) \in [A]^d$ be an arbitrary output letter of $V^{\oplus d}$. We construct from the output letter (a_0, \dots, a_{d-1}) the subset of at most d output letters

$$\mathcal{B}_0^d = \{(a_0, \dots, a_{d-1}), (a_0 \oplus 1, \dots, a_{d-1} \oplus 1), \dots, (a_0 \oplus (A-1), \dots, a_{d-1} \oplus (A-1))\} \quad (\text{C.1})$$

(if an output letter appears more than once in this construction then we take just one instance of it). Next, we take an output letter in $[A]^d \setminus \mathcal{B}_0^d$ and construct \mathcal{B}_1^d in the same manner as in (C.1). We continue constructing sets in this manner until $\bigcup_i \{\mathcal{B}_i^d\} = [A]^d$. Furthermore, it readily follows from the group property of the set $[A]$ with the modulo addition \oplus implies that $\mathcal{B}_{i_1}^d \cap \mathcal{B}_{i_2}^d$ is empty. Thus $\{\mathcal{B}_i^d\}$ is a partition of the output alphabet $[A]^d$. Now, assume that \mathcal{B}_i^d was generated, as in (C.1), from the output letter (a_0, \dots, a_{d-1}) . Then,

$$V_{|\mathcal{B}_i^d} = \begin{bmatrix} \prod_{i=0}^{d-1} V(a_i | 0) & \prod_{i=0}^{d-1} V(a_i \oplus 1 | 0) & \cdots & \prod_{i=0}^{d-1} V(a_i \oplus (A-1) | 0) \\ \prod_{i=0}^{d-1} V(a_i | 1) & \prod_{i=0}^{d-1} V(a_i \oplus 1 | 1) & \cdots & \prod_{i=0}^{d-1} V(a_i \oplus (A-1) | 1) \\ \vdots & \ddots & \ddots & \vdots \\ \prod_{i=0}^{d-1} V(a_i | A-1) & \prod_{i=0}^{d-1} V(a_i | A-2) & \cdots & \prod_{i=0}^{d-1} V(a_i \oplus (A-1) | A-1) \end{bmatrix} \quad (\text{C.2})$$

$$= \begin{bmatrix} \prod_{i=0}^{d-1} V(a_i | 0) & \prod_{i=0}^{d-1} V(a_i | A-1) & \cdots & \prod_{i=0}^{d-1} V(a_i | 1) \\ \prod_{i=0}^{d-1} V(a_i | 1) & \prod_{i=0}^{d-1} V(a_i | 0) & \cdots & \prod_{i=0}^{d-1} V(a_i | 2) \\ \vdots & \ddots & \ddots & \vdots \\ \prod_{i=0}^{d-1} V(a_i | A-1) & \prod_{i=0}^{d-1} V(a_i | A-2) & \cdots & \prod_{i=0}^{d-1} V(a_i | 0) \end{bmatrix} \quad (\text{C.3})$$

where the second equality follows since V is a modulo-additive channel. It is evident that $V_{|\mathcal{B}_i^d}$ is a circulant matrix, and hence doubly-permutation. As this is true for any subset \mathcal{B}_i^d , it holds that $V^{\oplus d}$ is symmetric in Gallager's sense. \blacksquare

We now turn to the proof of Prop. 38. The proof essentially exhausts all possible DMCs which satisfy the condition of the proposition. The first step is to identify all doubly-permutation matrices of up to 4 rows. In order to identify only matrices which are essentially different, we classify matrices U_1 and U_2 as *equivalent* if U_2 can be obtained from U_1 by row permutations followed by column permutations, and denote this relation by $U_1 \equiv U_2$. We say that a doubly-permutation matrix U is an *atom* if its columns cannot be partitioned into subsets $\{\mathcal{B}_i\}$ such that $V_{|\mathcal{B}_i}$ are doubly-permutation for all i .

Claim 39 (Taxonomy of small doubly-permutation atoms). Let U be a doubly-permutation matrix of r rows

and c columns. Then, any doubly-permutation matrix atom of $r = 2$ is equivalent to either

$$U_{(2,1)} := \begin{bmatrix} p_0 \\ p_0 \end{bmatrix}, U_{(2,2)} := \begin{bmatrix} p_0 & p_1 \\ p_1 & p_0 \end{bmatrix} \quad (\text{C.4})$$

for some p_0, p_1 ; of $r = 3$ is equivalent to either one of the following matrices

$$U_{(3,1)} := \begin{bmatrix} p_0 \\ p_0 \\ p_0 \end{bmatrix}, U_{(3,3)} := \begin{bmatrix} p_0 & p_1 & p_2 \\ p_1 & p_2 & p_0 \\ p_2 & p_0 & p_1 \end{bmatrix} \quad (\text{C.5})$$

for some p_0, p_1, p_2 ; and of $r = 4$ is equivalent to either one of the following matrices

$$U_{(4,1)} := \begin{bmatrix} p_0 \\ p_0 \\ p_0 \\ p_0 \end{bmatrix}, U_{(4,2)} := \begin{bmatrix} p_0 & p_1 \\ p_0 & p_1 \\ p_1 & p_0 \\ p_1 & p_0 \end{bmatrix}, \quad (\text{C.6})$$

$$U_{(4,4)}^{(\text{A})} := \begin{bmatrix} p_0 & p_1 & p_2 & p_3 \\ p_1 & p_0 & p_3 & p_2 \\ p_2 & p_3 & p_0 & p_1 \\ p_3 & p_2 & p_1 & p_0 \end{bmatrix}, U_{(4,4)}^{(\text{B})} := \begin{bmatrix} p_0 & p_1 & p_2 & p_3 \\ p_1 & p_0 & p_3 & p_2 \\ p_2 & p_3 & p_1 & p_0 \\ p_3 & p_2 & p_0 & p_1 \end{bmatrix}, \quad (\text{C.7})$$

$$U_{(4,4)}^{(\text{C})} := \begin{bmatrix} p_0 & p_1 & p_2 & p_3 \\ p_1 & p_2 & p_3 & p_0 \\ p_2 & p_3 & p_0 & p_1 \\ p_3 & p_0 & p_1 & p_2 \end{bmatrix}, U_{(4,4)}^{(\text{D})} := \begin{bmatrix} p_0 & p_1 & p_2 & p_3 \\ p_1 & p_3 & p_0 & p_2 \\ p_2 & p_0 & p_3 & p_1 \\ p_3 & p_2 & p_1 & p_0 \end{bmatrix}. \quad (\text{C.8})$$

for some p_0, p_1, p_2, p_3 .

Proof: All these matrices can be found either an automated or a manual exhaustive search procedure, in which all doubly-permutation atom U will be constructed. Few general properties may aid this search :

- If all rows of U are equal then it is not an atom, and thus henceforth we ignore these matrices.
- If $c = 1$ then the matrix $U = [p_0, p_0, \dots]^T$ is doubly-permutation and an atom for any $r \geq 1$. Thus, we next only consider $c > 1$.
- $c \leq r$ must hold. Indeed, assume by contradiction that $c > r$ then as we have assumed that all entries of the first row are unique, at least one of these elements does not appear in the first column. Since the columns are permutation of one another, that element does not appear in any of the other columns too, a contradiction.

In what follows, we will refer to the requirement that U has rows (respectively columns) which are permutations

of one another as the row-permutation *property* (respectively column-permutation *property*). In addition, we will refer to the fact that permuting the rows (respectively columns) leads to an equivalent matrix by row-permutation *equivalence* (respectively column-permutation *equivalence*). If both row- and column-permutation equivalence are used, we will refer to this as permutation equivalence.

We first consider the case in which the first row of U has *unique* entries. Under this assumption, it further holds that:

- If $c = r$, it can be assumed by permutation equivalence that the first row of U , say $(p_0, p_1, \dots, p_{r-1})$ is the transpose of its first column. Indeed, if this is not case, and the first column of U is not comprised of the values $\{p_0, p_1, \dots, p_{r-1}\}$ – one time each – then there is some p_i which does not appear in the first column, and by the column-permutation property, not anywhere in U , which is a contradiction.

We now go over all possible dimensions:

Case 1. $r = 2$. The only 2×2 atom is clearly $U_{(2,2)}$.

Case 2. $r = 3$ and $c = 2$. By the row-permutation property any doubly-permutation matrix is equivalent to $\begin{bmatrix} p_0 & p_1 \\ p_1 & p_0 \\ p_0 & p_1 \end{bmatrix}$. By the column-permutation property $p_0 = p_1$ must hold, and so the resulting matrix is not an atom.

Case 3. $r = 3$ and $c = 3$. We may first set the first row of U to (p_0, p_1, p_2) and the first column to its transpose. From this point, there is only a single way to complete the matrix to assure the doubly-permutation property, as in $U_{(3,3)}$.

Case 4. $r = 4$ and $c = 2$. By the row-permutation property, the rows of U must be either (p_0, p_1) or (p_1, p_0) . The only way to satisfy the column-permutation property is by having two rows of (p_0, p_1) and two rows of (p_1, p_0) , as in $U_{(4,2)}$.

Case 5. $r = 4$ and $c = 3$. Let the first row of U be (p_0, p_1, p_2) . If we set $U(2,1) = p_0$, then we can complete the second row either with (p_1, p_2) or (p_2, p_1) . Assuming the former for example, by the column-permutation property, we must complete U as

$$\begin{bmatrix} p_0 & p_1 & p_2 \\ p_0 & p_1 & p_2 \\ * & p_0 & p_0 \\ * & p_0 & p_0 \end{bmatrix} \quad (\text{C.9})$$

which cannot satisfy the row-permutation property. Thus we cannot set $U(2,1) = p_0$, given the first row. Suppose that given the first row, we set $U(2,1) \neq p_0$, which can be taken w.l.o.g as $U(2,1) = p_1$. Then, we may complete the second row either with (p_0, p_2) or (p_2, p_0) . Suppose that

we set the former (p_0, p_2) , then by the column-permutation property, we must complete U as

$$\begin{bmatrix} p_0 & p_1 & p_2 \\ p_1 & p_0 & p_2 \\ p_2 & p_2 & * \\ p_2 & p_2 & * \end{bmatrix} \quad (\text{C.10})$$

which cannot satisfy the row-permutation property. Suppose that we set the latter (p_2, p_0) . Then, by the column-permutation property we can set $U(3, 1) = p_2$. Then, by row-permutation property, we must complete the third row in either of these two ways:

$$\begin{bmatrix} p_0 & p_1 & p_2 \\ p_1 & p_2 & p_0 \\ p_2 & p_0 & p_1 \\ * & * & * \end{bmatrix}, \begin{bmatrix} p_0 & p_1 & p_2 \\ p_1 & p_2 & p_0 \\ p_2 & p_1 & p_0 \\ * & * & * \end{bmatrix} \quad (\text{C.11})$$

Both evidently cannot be completed to be doubly-permutation. Thus, there is no 4×3 doubly-permutation matrix.

Case 6. $r = 4$ and $c = 4$. Let the first row of U be (p_0, p_1, p_2, p_3) and set its first column to its transpose. To satisfy the column-permutation property, there are 3 ways to complete the second row (p_0, p_3, p_2) , (p_2, p_3, p_0) (p_3, p_0, p_2) (otherwise, there is a column with two identical values). Then, using the row- and column-permutation properties, we may complete the matrix in either of the following ways:

$$\begin{bmatrix} p_0 & p_1 & p_2 & p_3 \\ p_1 & p_0 & p_3 & p_2 \\ p_2 & * & * & * \\ p_3 & * & * & * \end{bmatrix} \rightarrow \begin{bmatrix} p_0 & p_1 & p_2 & p_3 \\ p_1 & p_0 & p_3 & p_2 \\ p_2 & p_3 & * & * \\ p_3 & p_2 & * & * \end{bmatrix} \rightarrow U_{(4,4)}^{(A)}, U_{(4,4)}^{(B)}. \quad (\text{C.12})$$

$$\begin{bmatrix} p_0 & p_1 & p_2 & p_3 \\ p_1 & p_2 & p_3 & p_0 \\ p_2 & * & * & * \\ p_3 & * & * & * \end{bmatrix} \rightarrow \begin{bmatrix} p_0 & p_1 & p_2 & p_3 \\ p_1 & p_2 & p_3 & p_0 \\ p_2 & p_3 & * & * \\ p_3 & p_0 & * & * \end{bmatrix} \rightarrow \begin{bmatrix} p_0 & p_1 & p_2 & p_3 \\ p_1 & p_2 & p_3 & p_0 \\ p_2 & p_3 & p_0 & * \\ p_3 & p_0 & p_1 & * \end{bmatrix} \rightarrow U_{(4,4)}^{(C)} \quad (\text{C.13})$$

$$\begin{bmatrix} p_0 & p_1 & p_2 & p_3 \\ p_1 & p_3 & p_0 & p_2 \\ p_2 & * & * & * \\ p_3 & * & * & * \end{bmatrix} \rightarrow \begin{bmatrix} p_0 & p_1 & p_2 & p_3 \\ p_1 & p_3 & p_0 & p_2 \\ p_2 & p_0 & * & * \\ p_3 & p_2 & * & * \end{bmatrix} \rightarrow \begin{bmatrix} p_0 & p_1 & p_2 & p_3 \\ p_1 & p_3 & p_0 & p_2 \\ p_2 & p_0 & p_3 & * \\ p_3 & p_2 & p_1 & * \end{bmatrix} \rightarrow U_{(4,4)}^{(D)}. \quad (\text{C.14})$$

This exhausts all possible cases with unique first row entries. Now suppose the first row of U does not have

unique entries. If $c = 2$ then this cannot lead to an atom, and so we consider only $c = 3$ and $c = 4$.

Case 1. $r = 3$ and $c = 3$. By column-permutation equivalence, we may set the first row of U to (p_0, p_0, p_1) where $p_0 \neq p_1$. Since the first column must contain p_1 we may then set $U(2, 1) = p_1$. This leads to a matrix which is equivalent to $U_{(3,3)}$.

Case 2. $r = 4$ and $c = 3$. By column-permutation equivalence, we may first set the first row of U to (p_0, p_0, p_1) where $p_0 \neq p_1$. Since the first column must contain p_1 we may then set $U(2, 1) = p_1$. By the row-permutation property

$$\begin{bmatrix} p_0 & p_0 & p_1 \\ p_1 & * & * \\ * & * & * \\ * & * & * \end{bmatrix} \rightarrow \begin{bmatrix} p_0 & p_0 & p_1 \\ p_1 & p_0 & p_0 \\ * & * & * \\ * & * & * \end{bmatrix}. \quad (\text{C.15})$$

Suppose we next set $U(3, 1) = p_0$. Then attempting to complete the third row with (p_0, p_1) violates the column-permutation property. Completing the third row with (p_1, p_0) leads to

$$\begin{bmatrix} p_0 & p_0 & p_1 \\ p_1 & p_0 & p_0 \\ p_0 & p_1 & p_0 \\ * & * & * \end{bmatrix} \quad (\text{C.16})$$

and attempting to complete the fourth row with any permutation of (p_0, p_0, p_1) violates the column-permutation property. Thus, $U(3, 1) = p_0$ is impossible, and so suppose we set $U(3, 1) = p_1$. Then, by the row-permutation property, the third row is completed with (p_0, p_0)

$$\begin{bmatrix} p_0 & p_0 & p_1 \\ p_1 & p_0 & p_0 \\ p_1 & p_0 & p_0 \\ * & * & * \end{bmatrix} \quad (\text{C.17})$$

which violates the column-permutation property. Thus, there are no atoms with $r = 4$ and $c = 3$, even with non-unique first row entries.

Case 3. $r = 4$ and $c = 4$. There are 3 sub-cases:

Case i. By column-permutation equivalence we may assume that the first row is (p_0, p_0, p_0, p_1) where $p_0 \neq p_1$. We may set $U(2, 1) = p_1$ and then by row-permutation property, we must complete the second row with (p_0, p_0, p_0) . Then, setting $U(3, 1) = p_1$ violates the column-permutation property, and so we set $U(3, 1) = p_0$. Then, there are two possible choices $U(3, 2) = p_0$ and $U(3, 2) = p_1$. After completing the matrix while preserving

column- and row- permutation properties, the resulting matrix is equivalent to $U_{(4,4)}^{(C)}$.

Case ii. By column-permutation equivalence we may assume that the first row is (p_0, p_0, p_1, p_2) where $\{p_0, p_1, p_2\}$ are unique. We may then set $U(2, 1) = p_1$ and $U(3, 1) = p_2$. Suppose we set $U(2, 2) = p_0$. By column- and row-permutation properties

$$\begin{aligned} \begin{bmatrix} p_0 & p_0 & p_1 & p_2 \\ p_1 & p_0 & * & * \\ p_2 & * & * & * \\ * & * & * & * \end{bmatrix} &\rightarrow \begin{bmatrix} p_0 & p_0 & p_1 & p_2 \\ p_1 & p_0 & * & * \\ p_2 & * & * & * \\ p_0 & * & * & * \end{bmatrix} \rightarrow \begin{bmatrix} p_0 & p_0 & p_1 & p_2 \\ p_1 & p_0 & p_2 & p_0 \\ p_2 & * & * & * \\ p_0 & * & * & * \end{bmatrix} \\ &\rightarrow \begin{bmatrix} p_0 & p_0 & p_1 & p_2 \\ p_1 & p_0 & p_2 & p_0 \\ p_2 & p_1 & * & * \\ p_0 & p_2 & * & * \end{bmatrix} \rightarrow \begin{bmatrix} p_0 & p_0 & p_1 & p_2 \\ p_1 & p_0 & p_2 & p_0 \\ p_2 & p_1 & p_0 & p_0 \\ p_0 & p_2 & p_0 & p_1 \end{bmatrix} \end{aligned}$$

which is equivalent to $U_{(4,4)}'''$. Next, suppose we set $U(2, 2) = p_2$. By the By row- and column-permutation properties

$$\begin{bmatrix} p_0 & p_0 & p_1 & p_2 \\ p_1 & p_2 & * & * \\ p_2 & * & * & * \\ * & * & * & * \end{bmatrix} \rightarrow \begin{bmatrix} p_0 & p_0 & p_1 & p_2 \\ p_1 & p_2 & p_0 & p_0 \\ p_2 & * & * & * \\ * & * & * & * \end{bmatrix}. \quad (\text{C.18})$$

If we set $U(3, 2) = p_1$ then this leads to

$$\begin{bmatrix} p_0 & p_0 & p_1 & p_2 \\ p_1 & p_2 & p_0 & p_0 \\ p_2 & p_1 & p_0 & p_0 \\ * & * & * & * \end{bmatrix} \rightarrow \begin{bmatrix} p_0 & p_0 & p_1 & p_2 \\ p_1 & p_2 & p_0 & p_0 \\ p_2 & p_1 & p_0 & p_0 \\ p_0 & p_0 & p_2 & p_1 \end{bmatrix} \quad (\text{C.19})$$

which is equivalent to $U_{(4,4)}'$. If we set $U(3, 2) = p_0$ then we may only complete the third row either with (p_0, p_1) as otherwise the column-permutation property is violated. This leads to

$$\begin{bmatrix} p_0 & p_0 & p_1 & p_2 \\ p_1 & p_2 & p_0 & p_0 \\ p_2 & p_0 & p_0 & p_1 \\ * & * & * & * \end{bmatrix} \rightarrow \begin{bmatrix} p_0 & p_0 & p_1 & p_2 \\ p_1 & p_2 & p_0 & p_0 \\ p_2 & p_0 & p_0 & p_1 \\ p_0 & p_1 & p_2 & p_0 \end{bmatrix} \quad (\text{C.20})$$

which is equivalent to $U_{(4,4)}'''$.

Case iii. By column-permutation equivalence we may assume that the first row is (p_0, p_0, p_1, p_1)

where $p_0 \neq p_1$. We may then set $U(2,1) = p_1$. Suppose we next set $U(2,2) = p_0$. Then we complete the second row with either (p_0, p_1) or (p_1, p_0) . Assuming the former (p_0, p_1) , the row- and column- properties lead to two possibilities

$$\begin{bmatrix} p_0 & p_0 & p_1 & p_1 \\ p_1 & p_0 & p_0 & p_1 \\ * & * & * & * \\ * & * & * & * \end{bmatrix} \rightarrow \begin{bmatrix} p_0 & p_0 & p_1 & p_1 \\ p_1 & p_0 & p_0 & p_1 \\ * & p_1 & * & p_0 \\ * & p_1 & * & p_0 \end{bmatrix} \rightarrow \left\{ \begin{array}{l} \begin{bmatrix} p_0 & p_0 & p_1 & p_1 \\ p_1 & p_0 & p_0 & p_1 \\ p_1 & p_1 & p_0 & p_0 \\ p_0 & p_1 & p_1 & p_0 \end{bmatrix} \\ \begin{bmatrix} p_0 & p_0 & p_1 & p_1 \\ p_1 & p_0 & p_0 & p_1 \\ p_0 & p_1 & p_1 & p_0 \\ p_1 & p_1 & p_0 & p_0 \end{bmatrix} \end{array} \right. \quad (\text{C.21})$$

which are both equivalent to $U'''_{(4,4)}$. Complete the second row with (p_1, p_0) leads to a similar result. Now, suppose we set $U(2,2) = p_1$. By row-permutation property, we may complete the second row with (p_0, p_0) . There are four ways to set $U(3,1)$ and $U(3,2)$. By symmetry, we may consider (p_0, p_0) and (p_1, p_0) . By row- and column- permutation properties, the first possibility leads to

$$\begin{bmatrix} p_0 & p_0 & p_1 & p_1 \\ p_1 & p_1 & p_0 & p_0 \\ p_0 & p_0 & * & * \\ * & * & * & * \end{bmatrix} \rightarrow \begin{bmatrix} p_0 & p_0 & p_1 & p_1 \\ p_1 & p_1 & p_0 & p_0 \\ p_0 & p_0 & p_1 & p_1 \\ * & * & * & * \end{bmatrix} \rightarrow \begin{bmatrix} p_0 & p_0 & p_1 & p_1 \\ p_1 & p_1 & p_0 & p_0 \\ p_0 & p_0 & p_1 & p_1 \\ p_1 & p_1 & p_0 & p_0 \end{bmatrix} \quad (\text{C.22})$$

which is not an atom (the first subset is the first and third columns and the second one

is its complement). Similarly, the second possibility leads to

$$\begin{bmatrix} p_0 & p_0 & p_1 & p_1 \\ p_1 & p_1 & p_0 & p_0 \\ p_1 & p_0 & * & * \\ * & * & * & * \end{bmatrix} \rightarrow \begin{bmatrix} p_0 & p_0 & p_1 & p_1 \\ p_1 & p_1 & p_0 & p_0 \\ p_1 & p_0 & * & * \\ p_0 & p_1 & * & * \end{bmatrix} \rightarrow \left\{ \begin{array}{l} \begin{bmatrix} p_0 & p_0 & p_1 & p_1 \\ p_1 & p_1 & p_0 & p_0 \\ p_1 & p_0 & p_1 & p_0 \\ p_0 & p_1 & p_0 & p_1 \end{bmatrix} \\ \begin{bmatrix} p_0 & p_0 & p_1 & p_1 \\ p_1 & p_1 & p_0 & p_0 \\ p_1 & p_0 & p_0 & p_1 \\ p_0 & p_1 & p_1 & p_0 \end{bmatrix} \end{array} \right. \quad (\text{C.23})$$

where the first is not an atom, and the second is equivalent to $U'''_{(4,4)}$.

This exhausts all possible cases with non-unique first row entries, and completes the proof. \blacksquare

Now, consider a DMC $V: \mathcal{A} \rightarrow \mathcal{B}$ which is symmetric in Gallager's sense and for which $|\mathcal{A}| \leq 4$ and $|\mathcal{B}| \leq |\mathcal{A}|$.

Claim 39 restricts the number of such channels.

Claim 40. Let $V: \mathcal{A} \rightarrow \mathcal{B}$ be a DMC with $|\mathcal{A}| \leq 4$ and $|\mathcal{B}| \leq |\mathcal{A}|$ which is symmetric in Gallager's sense, and does not have equal rows.²⁹ Then,

- If $|\mathcal{A}| = 2$ then $V \equiv U_{(2,2)}$.
- If $|\mathcal{A}| = 3$ then $V \equiv U_{(3,3)}$.
- If $|\mathcal{A}| = 4$ then V is equivalent to either one of $U_{(4,4)}^{(A)}, U_{(4,4)}^{(B)}, U_{(4,4)}^{(C)}, U_{(4,4)}^{(D)}$ or to

$$U_{(4,4)}^{(E)} := \begin{bmatrix} p_0 & p_1 & p_2 & p_3 \\ p_0 & p_1 & p_3 & p_2 \\ p_1 & p_0 & p_2 & p_3 \\ p_1 & p_0 & p_3 & p_2 \end{bmatrix} \quad (\text{C.24})$$

Proof: The case $|\mathcal{B}| = 1$, and the partition of \mathcal{B} to $|\mathcal{B}|$ subsets of size 1 leads to identical rows (and zero capacity) and thus can be ignored. Then, the only cases for $|\mathcal{A}| = 2$ (respectively $|\mathcal{A}| = 3$) are $|\mathcal{B}| = 2$ (respectively $|\mathcal{B}| = 3$) and the claim follows directly from Claim 39, since there are no non-trivial ways to partition \mathcal{B} . For $|\mathcal{A}| = 4$, we may consider either $|\mathcal{B}| = 2$, $|\mathcal{B}| = 3$ and $|\mathcal{B}| = 4$. For $|\mathcal{B}| = 2$, $V \equiv U_{(4,2)}$ which leads to identical

²⁹If two rows are equal they can be combined into a single input letter, thus effectively reduce $|\mathcal{A}|$.

rows, and thus ignored. For $|\mathcal{B}| = 3$ the only symmetric channel in Gallager's sense is

$$[U_{(4,1)}, U_{(4,2)}] = \begin{bmatrix} p_0 & p_1 & p_2 \\ p_0 & p_1 & p_2 \\ p_0 & p_2 & p_1 \\ p_0 & p_2 & p_1 \end{bmatrix} \quad (\text{C.25})$$

which again has identical rows, and thus can be ignored (it effectively creates a channel of size 2×3 for which we make no claims). For $|\mathcal{B}| = 4$ we may partition the output alphabet to subsets of sizes $(1, 1, 1, 1)$, $(2, 1, 1)$, $(2, 2)$ and $(4, 0)$. In the case of no partition $(4, 0)$ Claim 39 directly implies that V is equivalent to either $U_{(4,4)}^{(A)}$, $U_{(4,4)}^{(B)}$, $U_{(4,4)}^{(C)}$, or $U_{(4,4)}^{(D)}$. The case $(1, 1, 1, 1)$ can be ignored, as discussed above. Next, the case $(2, 1, 1)$ leads to identical rows and thus can be ignored. It remains to consider the case $(2, 2)$. In this case V is equivalent to

$$[U_{(4,2)}, \Pi[U_{(4,2)}]] \quad (\text{C.26})$$

for some row permutation Π . All such channels with non-equal rows are equivalent to $U_{(4,4)}^{(E)}$. ■

We now turn to binomial extension of channels. In principle, the output alphabet of the binomial channel $V^{\oplus d}$ is \mathcal{B}^d . However, since $V^{\oplus d}(b^d | a)$ only depends on a and the composition of b^d , we may assume that the output alphabet of $V^{\oplus d}$ is the set of all compositions in \mathcal{B}^d . Specifically, we change the output alphabet to

$$\tilde{\mathcal{B}}^{(d)} := \left\{ \delta^{|\mathcal{B}|} \in [d+1]^{|\mathcal{B}|} : \delta_b \in \mathbb{N}^+, \sum_{b \in \mathcal{B}} \delta_b = d \right\} \quad (\text{C.27})$$

where with this representation $\delta^{|\mathcal{B}|} = \mathcal{N}(b^d)$, that is δ_b is the number of times $b \in \mathcal{B}$ appears in the composition, such that the probability of this output alphabet under a is

$$V^{\oplus d}(\delta^{|\mathcal{B}|} | a) = \binom{d}{\delta_0, \delta_1, \dots, \delta_{|\mathcal{B}|-1}} \cdot \prod_{b \in \mathcal{B}} V^{\delta_b}(b | a). \quad (\text{C.28})$$

Proof of Prop. 38: By Claim 40, it suffices to verify the statement of Prop. 38 for the symmetric channels $U_{(2,2)}$, $U_{(3,3)}$ and $U_{(4,4)}^{(A)}$, $U_{(4,4)}^{(B)}$, $U_{(4,4)}^{(C)}$, $U_{(4,4)}^{(D)}$, $U_{(4,4)}^{(E)}$, while assuming p_0, p_1, p_2, p_3 are all unique. In fact, $U_{(2,2)}$ (BSC), $U_{(3,3)}$ and $U_{(4,4)}^{(C)}$ are modulo-additive channels, for which optimality of uniform input holds for general size input (output) alphabet in Sec. V.

To show that $V^{\oplus d}$ is symmetric in Gallager's sense, we need to prove that $\tilde{\mathcal{B}}^{(d)}$ can be partitioned into subsets, such that the columns and rows of the channel transition matrix restricted to each of the subsets is doubly-permutation.

Case 1. $V \equiv U_{(2,2)}$. Considering $\{(\delta_0, \delta_1), (\delta_1, \delta_0)\} \in \tilde{\mathcal{B}}^{(d)}$ we observe that

$$U_{(2,2)|\{(\delta_0, \delta_1), (\delta_1, \delta_0)\}} = \begin{pmatrix} d \\ \delta_0, \delta_1 \end{pmatrix} \cdot \begin{bmatrix} p_0^{\delta_0} p_1^{\delta_1} & p_0^{\delta_1} p_1^{\delta_0} \\ p_0^{\delta_0} & p_0^{\delta_1} p_1^{\delta_0} \end{bmatrix} \quad (\text{C.29})$$

which is doubly-permutation. Note that this subset may be degenerated, that is, only contain a single element $\delta_0 = \delta_1 = d/2$, but the claim holds for this case too. This is true for all next cases too.

Case 2. $V \equiv U_{(3,3)}$. Considering the subsets $\{(\delta_0, \delta_1, \delta_2), (\delta_1, \delta_2, \delta_0), (\delta_2, \delta_0, \delta_1)\} \in \tilde{\mathcal{B}}^{(d)}$ we observe that

$$U_{(3,3)|\{(\delta_0, \delta_1, \delta_2), (\delta_1, \delta_2, \delta_0), (\delta_2, \delta_0, \delta_1)\}} = \begin{pmatrix} d \\ \delta_0, \delta_1, \delta_2 \end{pmatrix} \times \begin{bmatrix} p_0^{\delta_0} \cdot p_1^{\delta_1} \cdot p_2^{\delta_2} & p_0^{\delta_2} \cdot p_1^{\delta_0} \cdot p_2^{\delta_1} & p_2^{\delta_0} \cdot p_0^{\delta_1} \cdot p_1^{\delta_2} \\ p_1^{\delta_0} \cdot p_2^{\delta_1} \cdot p_0^{\delta_2} & p_1^{\delta_2} \cdot p_2^{\delta_0} \cdot p_0^{\delta_1} & p_2^{\delta_0} \cdot p_0^{\delta_1} \cdot p_1^{\delta_2} \\ p_2^{\delta_0} \cdot p_0^{\delta_1} \cdot p_1^{\delta_2} & p_2^{\delta_2} \cdot p_0^{\delta_0} \cdot p_1^{\delta_1} & p_2^{\delta_0} \cdot p_0^{\delta_1} \cdot p_1^{\delta_2} \end{bmatrix}$$

which is doubly-permutation.

Case 3. $V \equiv U_{(4,4)}^{(A)}$. Considering the subsets

$$\{(\delta_0, \delta_1, \delta_2, \delta_3), (\delta_1, \delta_0, \delta_3, \delta_2), (\delta_2, \delta_3, \delta_0, \delta_1), (\delta_3, \delta_2, \delta_1, \delta_0)\} \quad (\text{C.30})$$

(the vectors are isomorphic to the rows of $U_{(4,4)}^{(A)}$), we observe that

$$U_{(4,4)}^{(A)} = \begin{bmatrix} p_0 & p_1 & p_2 & p_3 \\ p_1 & p_0 & p_3 & p_2 \\ p_2 & p_3 & p_0 & p_1 \\ p_3 & p_2 & p_1 & p_0 \end{bmatrix} \quad (\text{C.31})$$

we observe that

$$U_{(4,4)|\{(\delta_0, \delta_1, \delta_2, \delta_3), (\delta_1, \delta_0, \delta_3, \delta_2), (\delta_2, \delta_3, \delta_0, \delta_1), (\delta_3, \delta_2, \delta_1, \delta_0)\}}^{(A)} = \begin{pmatrix} d \\ \delta_0, \delta_1, \delta_2, \delta_3 \end{pmatrix} \times \begin{bmatrix} p_0^{\delta_0} \cdot p_1^{\delta_1} \cdot p_2^{\delta_2} \cdot p_3^{\delta_3} & p_0^{\delta_1} \cdot p_1^{\delta_0} \cdot p_2^{\delta_3} \cdot p_3^{\delta_2} & p_0^{\delta_2} \cdot p_1^{\delta_3} \cdot p_2^{\delta_0} \cdot p_3^{\delta_1} & p_0^{\delta_3} \cdot p_1^{\delta_2} \cdot p_2^{\delta_1} \cdot p_3^{\delta_0} \\ p_1^{\delta_0} \cdot p_2^{\delta_1} \cdot p_3^{\delta_2} \cdot p_0^{\delta_3} & p_1^{\delta_2} \cdot p_2^{\delta_0} \cdot p_3^{\delta_1} \cdot p_0^{\delta_3} & p_1^{\delta_3} \cdot p_2^{\delta_0} \cdot p_3^{\delta_1} \cdot p_0^{\delta_2} & p_1^{\delta_3} \cdot p_2^{\delta_2} \cdot p_3^{\delta_1} \cdot p_0^{\delta_0} \\ p_2^{\delta_0} \cdot p_3^{\delta_1} \cdot p_0^{\delta_2} \cdot p_1^{\delta_3} & p_2^{\delta_1} \cdot p_3^{\delta_0} \cdot p_0^{\delta_3} \cdot p_1^{\delta_2} & p_2^{\delta_2} \cdot p_3^{\delta_3} \cdot p_0^{\delta_0} \cdot p_1^{\delta_1} & p_2^{\delta_3} \cdot p_3^{\delta_2} \cdot p_0^{\delta_1} \cdot p_1^{\delta_0} \\ p_3^{\delta_0} \cdot p_2^{\delta_1} \cdot p_1^{\delta_2} \cdot p_0^{\delta_3} & p_3^{\delta_1} \cdot p_2^{\delta_0} \cdot p_1^{\delta_3} \cdot p_0^{\delta_2} & p_3^{\delta_2} \cdot p_2^{\delta_3} \cdot p_1^{\delta_0} \cdot p_0^{\delta_1} & p_3^{\delta_3} \cdot p_2^{\delta_2} \cdot p_1^{\delta_1} \cdot p_0^{\delta_0} \end{bmatrix}$$

which is doubly-permutation, and equivalent to $U_{(4,4)}^{(A)}$

Case 4. $V \equiv U_{(4,4)}^{(B)}$ and $V \equiv U_{(4,4)}^{(C)}$ $V \equiv U_{(4,4)}^{(D)}$ and $V \equiv U_{(4,4)}^{(E)}$ can be verified similarly to the previous case. ■

Counterexamples: We conclude this section we two counterexamples. The channel

$$W_1 = \frac{1}{15} \cdot \begin{bmatrix} 1 & 2 & 3 & 4 & 5 \\ 4 & 3 & 2 & 5 & 1 \\ 2 & 5 & 1 & 3 & 4 \\ 3 & 4 & 5 & 1 & 2 \\ 5 & 1 & 4 & 2 & 3 \end{bmatrix} \quad (\text{C.32})$$

is symmetric, yet $W_1^{\oplus 2}$ is not symmetric, not even in Gallager's sense. The channel³⁰

$$W_2 = \frac{1}{20} \cdot \begin{bmatrix} 1 & 2 & 3 & 4 & 1 & 2 & 3 & 4 \\ 2 & 1 & 4 & 3 & 2 & 1 & 4 & 3 \\ 3 & 4 & 1 & 2 & 3 & 4 & 2 & 1 \\ 4 & 3 & 2 & 1 & 4 & 3 & 1 & 2 \end{bmatrix} \quad (\text{C.33})$$

is symmetric in Gallager's sense, yet $W_2^{\oplus 2}$ is not symmetric in Gallager's sense. Furthermore, the capacity input distribution of both $W_1^{\oplus 2}$ and $W_2^{\oplus 2}$ is not uniform (though very close to being uniform, with deviation on the order of 10^{-3}).

B. Proof of Proposition 13

Proof of Prop. 13: We first loosen the upper bound of Theorem 10 by upper bounding

$$\begin{aligned} & I(P_X, W^{\oplus d}) + \Omega_d(\beta, P_X, W) \\ &= \begin{cases} I(P_X, W^{\oplus d}) + \frac{1}{\beta}, & \text{CID}(P_X, W^{\oplus d}) < \frac{1}{\beta} \\ I(P_X, W^{\oplus d}) - \text{CID}(P_X, W^{\oplus d}) + \frac{2}{\beta}, & \frac{1}{\beta} \leq \text{CID}(P_X, W^{\oplus d}) < \frac{2}{\beta} \\ I(P_X, W^{\oplus d}), & \text{CID}(P_X, W^{\oplus d}) \geq \frac{2}{\beta} \end{cases} \quad (\text{C.34}) \end{aligned}$$

$$= \left[\left(I(P_X, W^{\oplus d}) + \frac{1}{\beta} \right) \wedge \left(\text{CID}(P_X, W^{\oplus d}) - \text{CID}(P_X, W^{\oplus d}) + \frac{2}{\beta} \right) \right] \vee \left[I(P_X, W^{\oplus d}) \right] \quad (\text{C.35})$$

$$\stackrel{(a)}{=} \left[I(P_X, W^{\oplus d}) + \frac{1}{\beta} \right] \wedge \left[\left(\text{CID}(P_X, W^{\oplus d}) - \text{CID}(P_X, W^{\oplus d}) + \frac{2}{\beta} \right) \vee \left(I(P_X, W^{\oplus d}) \right) \right] \quad (\text{C.36})$$

$$\leq \left(\text{CID}(P_X, W^{\oplus d}) - \text{CID}(P_X, W^{\oplus d}) + \frac{2}{\beta} \right) \vee I(P_X, W^{\oplus d}) \quad (\text{C.37})$$

where (a) follows from the distributive law for minima and maxima $(c_1 \vee c_2) \wedge c_3 = (c_1 \vee c_3) \wedge (c_2 \vee c_3)$ for $c_1, c_2, c_3 \in \mathbb{R}$ and since $1/\beta > 0$.

We next show that for any $d \in \mathbb{N}^+$, each of the two terms in the maximization of (C.37) is individually maximized by the uniform distribution $P_X^{(\text{unif})}$. First, $I(P_X, W^{\oplus d})$ is the mutual information of a symmetric

³⁰The channel matrix is a juxtaposition of two symmetric channels of sizes $|\mathcal{X}| = |\mathcal{Y}| = 4$.

channel (Prop. 37), and so clearly maximized by the uniform distribution $P_X^{(\text{unif})}$. Second, we let $(X, Y, \bar{Y}) \in \mathcal{X} \times \mathcal{Y}^2$ be such that

$$\mathbb{P}[X = x, Y^d = y^d, \bar{Y}^d = \bar{y}^d] = P_X(x) \cdot W^{\oplus d}(y^d | x) W^{\oplus d}(\bar{y}^d | x) \quad (\text{C.38})$$

for some $d \in \mathbb{N}^+$. Then,

$$I(P_X, W^{\oplus d}) - \text{CID}(P_X, W^{\oplus d}) = I(X, Y^d) - 2I(X; Y^d) + I(X; Y^d, \bar{Y}^d) \quad (\text{C.39})$$

$$= I(X; Y^d, \bar{Y}^d) - I(X; Y^d) \quad (\text{C.40})$$

$$= I(X; \bar{Y}^d | Y^d) \quad (\text{C.41})$$

$$= H(\bar{Y}^d | Y^d) - H(\bar{Y}^d | X, Y^d) \quad (\text{C.42})$$

$$\stackrel{(a)}{=} H(\bar{Y}^d | Y^d) - H(\bar{Y}^d | X) \quad (\text{C.43})$$

$$\stackrel{(b)}{=} H(\bar{Y}^d | Y^d) - H(\bar{Y}^d | X = x) \quad (\text{C.44})$$

where (a) follows from Markovity, and (b) holds for any $x \in \mathcal{X}$ and follows from the fact that W is a modulo-additive channel, for which the conditional output entropy $H(Y^d | X = x)$ does not depend on $x \in \mathcal{X}$. Indeed, if the noise p.m.f. in the modulo-additive channel is $\mathbb{P}[Z = z] = w_z$ for $z \in \mathcal{X}$, then the multiset of \mathcal{X}^d possible values of $\mathbb{P}[Y^d = y^d | X = x]$ is given by

$$\left\{ \prod_{i=0}^{d-1} w_{(y_i - x)} \right\}_{y^d \in \mathcal{X}^d} = \left\{ \prod_{i=0}^{d-1} w_{z_i} \right\}_{z^d \in \mathcal{X}^d} \quad (\text{C.45})$$

for any $x \in \mathcal{X}$. Thus, the P_X -maximizer of $I(P_X, W^{\oplus d}) - \text{CID}(P_X, W^{\oplus d}) + \frac{2}{\beta}$ over P_X is the maximizer of $H(\bar{Y}^d | Y^d)$. We next show that $H(\bar{Y}^d | Y^d)$ is maximized by the uniform distribution. To this end, we let $G(\omega, t) := t \cdot H(\frac{\omega}{t})$ be the *perspective function* of the entropy function, defined for $(\omega, t) \in [0, 1]^\infty \times \mathbb{R}^+$ such that $\frac{1}{t} \sum \omega_i = 1$ and $\omega_i/t \geq 0$. Then,

$$H(\bar{Y}^d | Y^d) = \sum_{y^d \in \mathcal{X}^d} P_{Y^d}(y^d) \cdot H\left(P_{\bar{Y}^d | Y^d}(\cdot | y^d)\right) \quad (\text{C.46})$$

$$= \sum_{y^d \in \mathcal{X}^d} P_{Y^d}(y^d) \cdot H\left(\frac{P_{Y^d \bar{Y}^d}(y^d, \cdot)}{P_{Y^d}(y^d)}\right) \quad (\text{C.47})$$

$$= \sum_{y^d \in \mathcal{X}^d} P_{Y^d}(y^d) \cdot H\left(\frac{\sum_{x \in \mathcal{X}} P_{X Y^d \bar{Y}^d}(x, y^d, \cdot)}{P_{Y^d}(y^d)}\right) \quad (\text{C.48})$$

$$= \sum_{y^d \in \mathcal{X}^d} P_{Y^d}(y^d) \cdot H\left(\frac{\sum_{x \in \mathcal{X}} P_X(x) \cdot P_{Y^d \bar{Y}^d | X}(\cdot, y^d | x)}{P_{Y^d}(y^d)}\right) \quad (\text{C.49})$$

$$\stackrel{(a)}{=} \sum_{y^d \in \mathcal{X}^d} P_{Y^d}(y^d) \cdot H\left(\frac{\sum_{x \in \mathcal{X}} P_X(x) \cdot P_{Y^d | X}(y^d | x) P_{\bar{Y}^d | X}(\cdot, | x)}{P_{Y^d}(y^d)}\right) \quad (\text{C.50})$$

$$= G \left(\sum_{x \in \mathcal{X}} P_X(x) \cdot P_{Y^d|X}(y^d | x) P_{\bar{Y}^d|X}(\cdot, | x), P_{Y^d}(y^d) \right) \quad (\text{C.51})$$

where (a) follows from Markovity. Now since the entropy function is concave, then so is $(\omega, t) \rightarrow G(\omega, t)$ [5, Sec. 3.2.6]. Furthermore, both the arguments of G in (C.51), to wit

$$\sum_{x \in \mathcal{X}} P_X(x) \cdot P_{Y^d|X}(y^d | x) P_{\bar{Y}^d|X}(\cdot, | x) \quad (\text{C.52})$$

and

$$P_{Y^d}(y^d) = \sum_{x \in \mathcal{X}} P_X(x) \cdot P_{Y^d|X}(y^d | x) \quad (\text{C.53})$$

are affine mappings of $\{P_X(x)\}_{x \in \mathcal{X}}$, and composition with an affine mapping preserves concavity [5, Sec. 3.2.2]. Thus, $H(\bar{Y}^d | Y^d)$ is a concave function of P_X . For any $z \in \mathcal{X}$, let $P_X^{(z)}$ be the distribution defined via

$$P_X^{(z)}(x) = P_X(x + z). \quad (\text{C.54})$$

Due to the symmetry in the modulo-additive channel, the entropy $H(\bar{Y}^d | Y^d)$ is the same for any choice $P_X^{(z)}(x)$ for any $z \in \mathcal{X}$. By concavity of $H(\bar{Y}^d | Y^d)$ in P_X , the distribution $\bar{P}_X = \frac{1}{|\mathcal{X}|} \sum_{z \in \mathcal{X}} P_X^{(z)}$ has larger $H(\bar{Y}^d | Y^d)$ than any for $P_X^{(z)}(x)$. However, \bar{P}_X is clearly the uniform distribution over \mathcal{X} .

We thus have shown that both terms in the maximization of (C.37) are maximized by the uniform distribution, for all $d \in \mathbb{N}^+$. Now, if $-\text{CID}(P_X^{(\text{unif})}, W^{\oplus d}) + \frac{2}{\beta} < 0$ for all $d \in \mathbb{N}^+$ then the resulting (loosened) upper bound on the capacity, obtained by replacing $I(P_X, W^{\oplus d}) + \Omega_d(\beta, P_X, W)$ with their upper bound in (C.37), is given by

$$\begin{aligned} & \max_{P_X \in \mathcal{P}(\mathcal{X})} \sum_{d \in \mathbb{N}^+} \pi_\alpha(d) \cdot \left[\left(I(P_X, W^{\oplus d}) - \text{CID}(P_X, W^{\oplus d}) + \frac{2}{\beta} \right) \vee \left(I(P_X, W^{\oplus d}) \right) \right] - \frac{1}{\beta} (1 - \pi_\alpha(0)) \\ & \leq \sum_{d \in \mathbb{N}^+} \pi_\alpha(d) \cdot \left[\max_{P_X \in \mathcal{P}(\mathcal{X})} \left(I(P_X, W^{\oplus d}) - \text{CID}(P_X, W^{\oplus d}) + \frac{2}{\beta} \right) \vee \left(\max_{P_X \in \mathcal{P}(\mathcal{X})} I(P_X, W^{\oplus d}) \right) \right] - \frac{1}{\beta} (1 - \pi_\alpha(0)) \end{aligned} \quad (\text{C.55})$$

$$= \sum_{d \in \mathbb{N}^+} \pi_\alpha(d) \cdot \left[\left(I(P_X^{(\text{unif})}, W^{\oplus d}) - \text{CID}(P_X^{(\text{unif})}, W^{\oplus d}) + \frac{2}{\beta} \right) \vee I(P_X^{(\text{unif})}, W^{\oplus d}) \right] - \frac{1}{\beta} (1 - \pi_\alpha(0)) \quad (\text{C.56})$$

$$= \sum_{d \in \mathbb{N}^+} \pi_\alpha(d) \cdot I(P_X^{(\text{unif})}, W^{\oplus d}) - \frac{1}{\beta} (1 - \pi_\alpha(0)) \quad (\text{C.57})$$

which matches the lower bound. Since $\text{CID}(P_X^{(\text{unif})}, W^{\oplus d})$ is monotonic increasing (Corollary 26) then this condition is satisfied if $\beta \geq 2/\text{CID}(P_X^{(\text{unif})}, W)$, as claimed. \blacksquare

C. Mutual Information of K DMC Uses with i.i.d. v.s. Fixed Composition Inputs

In this appendix, we consider K independent uses of a DMC $V: \mathcal{A} \rightarrow \mathcal{B}$, so the input is A^K and the output is $B^K \sim V^K(\cdot | A^K)$. In this channel, the maximal mutual information is obtained by choosing the input A_k to be i.i.d.. For the next lemma, we compare this maximal mutual information to that obtained by the K -dimensional mutual information obtained for $A^K \sim \text{Uniform}[\mathcal{T}_K(P_A)]$, that is, a uniform distribution over the type class $\mathcal{T}_K(P_A)$ (where we insist $P_A \in \mathcal{P}_K(\mathcal{A})$). The next lemma shows that the different in mutual information is $o(K)$.

Lemma 41. *Let a DMC $V: \mathcal{A} \rightarrow \mathcal{B}$, $K \in \mathbb{N}^+$ and $P_A \in \mathcal{P}_K(\mathcal{A})$ be given. Let A^K be distributed i.i.d. so that $A_k \sim P_A$ and let $\tilde{A}^K \sim \text{Uniform}[\mathcal{T}_K(P_A)]$. Let $B^K \sim V^K(\cdot | A^K)$ and $\tilde{B}^K \sim V^K(\cdot | \tilde{A}^K)$. Then,*

$$0 \leq I(A^K; B^K) - I(\tilde{A}^K; \tilde{B}^K) = O(\sqrt{K} \cdot \log K) = o(K). \quad (\text{C.58})$$

The constant involved in the asymptotic order term only depends on $|\mathcal{A}|, |\mathcal{B}|$.

Proof: The non-negativity of the mutual information difference in (C.58) stems from the fact that memoryless input distributions maximize mutual information for memoryless channels. We turn to prove the upper bound. To this end, write

$$I(A^K; B^K) - I(\tilde{A}^K; \tilde{B}^K) = H(A^K) - H(\tilde{A}^K) + H(B^K) - H(\tilde{B}^K) - H(A^K, B^K) + H(\tilde{A}^K, \tilde{B}^K). \quad (\text{C.59})$$

We upper bound each of the three entropy differences above. The first entropy difference can be easily bounded

$$H(A^K) - H(\tilde{A}^K) = K \cdot H(P_A) - \log |\mathcal{T}_K(P_A)| \leq |\mathcal{A}| \cdot \log(K+1) \quad (\text{C.60})$$

since \tilde{A}^K is distributed uniformly over $\mathcal{T}_K(P_A)$ and using $|\mathcal{T}_K(P_A)| \geq (K+1)^{-|\mathcal{A}|} \cdot e^{K \cdot H(P_A)}$ (from [11, Lemma 2.5]). We next turn to bound the *third* entropy difference, to wit, $H(A^K, B^K) - H(\tilde{A}^K, \tilde{B}^K)$. To bound this entropy difference we first bound the KL divergence between the distributions $P_{\tilde{A}^K \tilde{B}^K}$ and $P_{A^K B^K}$ of \tilde{A}^K, \tilde{B}^K (respectively A^K, B^K). Then, we use Marton's transportation inequality [29], [30] to bound Ornstein's \bar{d} -distance between these distributions. Finally, we use [36, Prop. 8] to bound the entropy difference using the bound on the Ornstein's \bar{d} -distance. We begin by bounding the KL divergence:

$$D(P_{\tilde{A}^K \tilde{B}^K} || P_{A^K B^K}) = D(P_{\tilde{A}^K} \times V^K || P_{A^K} \times V^K) \quad (\text{C.61})$$

$$= D(P_{\tilde{A}^K} || P_{A^K}) \quad (\text{C.62})$$

$$= \sum_{a^K \in \mathcal{A}^K} P_{\tilde{A}^K}(a^K) \log \frac{P_{\tilde{A}^K}(a^K)}{P_{A^K}(a^K)} \quad (\text{C.63})$$

$$= \sum_{a^K \in \mathcal{T}_K(P_A)} \frac{1}{|\mathcal{T}_K(P_A)|} \log \frac{1/|\mathcal{T}_K(P_A)|}{P_{A^K}(a^K)} \quad (\text{C.64})$$

$$\stackrel{(a)}{=} \log \frac{1}{P_{A^K}(\mathcal{T}_K(P_A))} \quad (\text{C.65})$$

$$\stackrel{(b)}{\leq} |\mathcal{A}| \cdot \log(K+1) \quad (\text{C.66})$$

where (a) since $P_{A^K}(a^K)$ is identical to all $a^K \in \mathcal{T}_K(P_A)$, and (b) follows since $P_{A^K}(\mathcal{T}_K(P_A)) \geq (K+1)^{-|\mathcal{A}|}$ [11, Proof of Lemma 2.3]. Now, let Ornstein's \bar{d} -distance between distributions over $(\mathcal{A} \times \mathcal{B})^K$ be ³¹

$$\bar{d}(P_{\tilde{A}^K \tilde{B}^K}, P_{A^K B^K}) := \frac{1}{K} \inf \mathbb{E} \left[\rho_H(\tilde{A}^K \tilde{B}^K, A^K B^K) \right] \quad (\text{C.67})$$

where for $(a^K, b^K), (\tilde{a}^K, \tilde{b}^K) \in (\mathcal{A} \times \mathcal{B})^K$

$$\rho_H \left((\tilde{a}^K, \tilde{b}^K), (a^K, b^K) \right) = \sum_{k \in [K]} \mathbb{1} \left\{ (a_k, b_k) \neq (\tilde{a}_k, \tilde{b}_k) \right\} \quad (\text{C.68})$$

is the Hamming distance, and the infimum is taken over all couplings $P_{\tilde{A}^K \tilde{B}^K A^K B^K}$ of $P_{\tilde{A}^K \tilde{B}^K}$ and $P_{A^K B^K}$. Now, since $P_{A^K B^K} = \prod_{k \in [K]} P_{A_k} \times P_{B_k}$ is a memoryless distribution, Marton's transportation inequality implies that

$$\bar{d}(P_{\tilde{A}^K \tilde{B}^K}, P_{A^K B^K}) \leq \sqrt{\frac{D(P_{\tilde{A}^K \tilde{B}^K} \| P_{A^K B^K})}{2K}} \leq \sqrt{\frac{|\mathcal{A}| \cdot \log(K+1)}{2K}} \quad (\text{C.69})$$

where the right inequality is from (C.66). As was stated in [36, Prop. 8],³² the \bar{d} -distance controls entropy difference, in the sense that for any pair of distributions $P_1, P_2 \in \mathcal{P}(\mathcal{A}^K)$,

$$|H(P_1) - H(P_2)| \leq \bar{d}(P_1, P_2) \cdot K \cdot \log(|\mathcal{A}|-1) + h_b(\bar{d}(P_1, P_2)). \quad (\text{C.70})$$

Thus for all K large enough so that $\bar{d}(P_{\tilde{A}^K \tilde{B}^K}, P_{A^K B^K}) < 1/2$ it holds that

$$\begin{aligned} & \left| H(A^K, B^K) - H(\tilde{A}^K, \tilde{B}^K) \right| \\ & \stackrel{(a)}{\leq} K \cdot \left[\bar{d}(P_{\tilde{A}^K \tilde{B}^K}, P_{A^K B^K}) \cdot (\log|\mathcal{A} \times \mathcal{B}|-1) + h_b(\bar{d}(P_{\tilde{A}^K \tilde{B}^K}, P_{A^K B^K})) \right] \end{aligned} \quad (\text{C.71})$$

$$\stackrel{(b)}{\leq} K \cdot \left[\bar{d}(P_{\tilde{A}^K \tilde{B}^K}, P_{A^K B^K}) \cdot (\log|\mathcal{A} \times \mathcal{B}|-1) + 2\bar{d}(P_{\tilde{A}^K \tilde{B}^K}, P_{A^K B^K}) \log \frac{1}{\bar{d}(P_{\tilde{A}^K \tilde{B}^K}, P_{A^K B^K})} \right] \quad (\text{C.72})$$

$$\stackrel{(c)}{=} O(\sqrt{K} \cdot \log K) = o(K). \quad (\text{C.73})$$

where (a) follows from (C.70), (b) follows from $h_b(t) \leq -2t \log t$ for all $t \leq 1/2$, and (c) follows from (C.69). This completes the bound on the third entropy-difference term in (C.59). The bound of the second entropy-difference term $H(B^K) - H(\tilde{B}^K)$ is similar to the third one since by the lumping property of the KL divergence and (C.66)

$$D(P_{\tilde{B}^K} \| P_{B^K}) \leq D(P_{\tilde{A}^K \tilde{B}^K} \| P_{A^K B^K}) \leq |\mathcal{A}| \cdot \log(K+1). \quad (\text{C.74})$$

³¹The \bar{d} distance function denoted here is not related to the constant \bar{d} used in the proofs.

³²This is a generalization to $K > 1$ of [3], [46].

Combining the bounds on the three entropy-difference terms and inserting to (C.59) completes the proof. ■

APPENDIX D

COMPUTATIONAL ASPECTS OF THE BOUNDS

Capacity lower bound: In general, the infinite sum in (12) can be truncated to a finite sum ending at $\bar{d} < \infty$, so that if $\sum_{d \in \mathbb{N}^+ \setminus [\bar{d}]} \pi_\alpha(d) \leq \epsilon$ then the loss in the capacity bound is at most $\epsilon \log |\mathcal{X}|$. Regarding the maximization over P_X , since $I(P_X, W^{\oplus d})$ is a concave function of P_X , then so is the capacity lower bound. It should be noted that while \bar{d} should be chosen finite, it does not have to be small. Naively, the output alphabet size of $W^{\oplus d}$ is indeed $|\mathcal{Y}|^d$, however, since $W^{\oplus d}(y^d | x)$ only depends on x and the type $\mathcal{P}(y^d)$, it holds that if the output letters $y^d, \bar{y}^d \in \mathcal{Y}^d$ of $W^{\oplus d}$ satisfy $\mathcal{P}(y^d) = \mathcal{P}(\bar{y}^d)$, then $W(y^d | x) = W(\bar{y}^d | x)$ is the same for all $x \in \mathcal{X}$, and the two letters can be merged to a single output letter, without changing the mutual information. For example, if W is a BSC with crossover probability w and $d = 3$, then $W^{\oplus 3}$ has the output letters $\{000, 100, 110, 111\}$. In general, the number of merged output letters is simply the number of output types $|\mathcal{P}_d(\mathcal{Y})| = \binom{d+|\mathcal{Y}|-1}{|\mathcal{Y}|-1} \leq (d+1)^{|\mathcal{Y}|}$ (by [11], or by the stars and bars model, see footnote 17), which is only polynomial in d .

Reliability function lower bound: As for capacity, a computationally feasible bound can be obtained by restricting the infinite sums in (15) and (16) to (even different) finite value \bar{d} , and replacing $\sum_{d \in \mathbb{N}} \theta_d = 1$ with $\sum_{d \in [\bar{d}]} \theta_d \leq 1$ (this can be deduced from the Proof of Theorem 8). Assuming such a truncation, the minimization over $\{\theta_d\}_{d \in [\bar{d}]}$ is a convex optimization problem. To see this, let $\mu = 1 - \sum_{i \in [d]} \theta_i$ and consider the d th term in the sum, i.e., $\mu \cdot d_b(\frac{\theta_d}{\mu} || \pi_{\alpha \geq d}(d))$. Since $\theta \rightarrow d_b(\theta || \pi)$ is convex in θ , its perspective function $(\mu, \theta) \rightarrow \mu \cdot d_b(\frac{\theta}{\mu} || \pi)$ is jointly convex in (μ, θ) for $\frac{\theta}{\mu} \in [0, 1]$ and $\mu > 0$ [5, Sec. 3.2.6]. A composition of a linear function $\mu = 1 - \sum_{i \in [d]} \theta_i$ with a convex function results a convex function. Thus any of the \bar{d} terms in the (truncated) sum of (15) is convex, and so is their sum. The next step is maximization over P_X , which can be simply performed by a grid search over the $(|\mathcal{X}|-1)$ -dimensional simplex $\mathcal{P}(\mathcal{X})$. In principle, it can be shown that maximization-minimization optimization problem is concave-convex over $P_X \in \mathcal{P}(\mathcal{X})$ and $\{\theta_d\}_{d \in \bar{d}} \in \mathcal{P}_{\text{sub}}(\bar{d})$, where $\mathcal{P}_{\text{sub}}(\bar{d}) := \sum_{d \in [\bar{d}]} \theta_d \leq 1$, by using strong Lagrange duality [5, Sec. 5.2.3] to cast (15) as a Lagrange optimization problem. However, since there are two constraints in (16) (beyond the interval constraints $\theta_d \in (0, 1]$), the resulting optimization problem requires searching over Lagrange multipliers $(\lambda_0, \lambda_1) \in (\mathbb{R}^+)^2$, and solving a concave-convex maximization-minimization optimization problem for each (which can nonetheless be efficiently solved, e.g. [6, Sec. 5.2]). However, while this extra complication compared to a simple grid search over $\mathcal{P}(\mathcal{X})$ is feasible, it does not seem to be computationally beneficial here, since for the DNA channel $|\mathcal{X}| = 4$ is typical, and thus the grid search is merely three-dimensional.

Capacity upper bound: First, as for the lower bound on capacity, the infinite sum in (24) can be truncated to a finite value \bar{d} , so that if $\sum_{d \in \mathbb{N}^+ \setminus \bar{d}} \pi_\alpha(d) \leq \epsilon$ then the loss in capacity bound is at most $\epsilon \log |\mathcal{X}|$. Assuming

that this approximation has been made, the next computational step is the maximization over P_X . While we cannot propose any general computationally effective algorithm for this task, in a practical DNA channel $|\mathcal{X}|=4$, and so, the maximization problem is only three-dimensional, and it can be easily solved by standard global optimization methods. It should be noted, however, that the computation of the upper bound is more complex than the lower bound. Specifically, for a given d , the computation of the upper bound requires computing $\text{CID}(P_X, W^{\oplus d})$, which, in turn requires computing the mutual information $I(P_X, W^{\oplus(2^d)})$ which has larger output alphabet size than $I(P_X, W^{\oplus d})$. As said, however, the effective output size of $W^{\oplus d}$ increase rather slowly as $(d+1)^{|\mathcal{Y}|}$.

REFERENCES

- [1] P. L. Antkowiak, J. Lietard, M. Z. Darestani, M. M. Somoza, W. J. Stark, R. Heckel, and R. N. Grass. Low cost DNA data storage using photolithographic synthesis and advanced information reconstruction and error correction. *Nature communications*, 11(1):1–10, 2020.
- [2] T. M. Apostol. *Modular Functions and Dirichlet Series in Number Theory*. Graduate Texts in Mathematics. Springer New York, 2012.
- [3] K. M. R. Audenaert. A sharp Fannes-type inequality for the von Neumann entropy. *arXiv preprint quant-ph/0610146*, 2006.
- [4] J. Bornholt, R. Lopez, D. M. Carmean, L. Ceze, G. Seelig, and K. Strauss. A DNA-based archival storage system. In *Proceedings of the Twenty-First International Conference on Architectural Support for Programming Languages and Operating Systems*, pages 637–649, 2016.
- [5] S. P. Boyd and L. Vandenberghe. *Convex Optimization*. Cambridge University Press, 2004.
- [6] S. Bubeck. Convex optimization: Algorithms and complexity. *arXiv preprint arXiv:1405.4980*, 2014.
- [7] G. M. Church, Y. Gao, and S. Kosuri. Next-generation digital information storage in DNA. *Science*, 337(6102):1628–1628, 2012.
- [8] T. M. Cover and J. A. Thomas. *Elements of Information Theory*. Wiley-Interscience, Hoboken, NJ, USA, 2006.
- [9] I. Csiszár. Joint source-channel error exponent. *Problems of Control and Information Theory*, 9(5):315–327, 1980.
- [10] I. Csiszár. The method of types. *IEEE Transactions on Information Theory*, 44(6):2505–2523, 1998.
- [11] I. Csiszár and J. Körner. *Information Theory: Coding Theorems for Discrete Memoryless Systems*. Cambridge University Press, Cambridge, U.K., 2011.
- [12] I. Csiszár, J. Körner, and K. Marton. A new look at the error exponent of discrete memoryless channels. In *IEEE International Symposium on Information Theory*, 1977. unpublished.
- [13] R. Durrett. *Probability: Theory and examples*, volume 49. Cambridge University Press, 2019.
- [14] Y. Erlich and D. Zielinski. DNA fountain enables a robust and efficient storage architecture. *Science*, 355(6328):950–954, 2017.
- [15] R. Gabrys, H. M. Kiah, and O. Milenkovic. Asymmetric Lee distance codes: New bounds and constructions. In *2015 IEEE Information Theory Workshop*, pages 1–5. IEEE, 2015.
- [16] R. G. Gallager. *Information Theory and Reliable Communication*. John Wiley and Sons, 1968.
- [17] N. Goldman, S. Bertone, P. and Chen, C. Dessimoz, E. M. LeProust, B. Sipos, and E. Birney. Towards practical, high-capacity, low-maintenance information storage in synthesized DNA. *Nature*, 494(7435):77–80, 2013.
- [18] V. D. Goppa. Nonprobabilistic mutual information without memory. *Problems of Control and Information Theory*, 4(2):97–102, 1975.
- [19] R. N. Grass, R. Heckel, M. Puddu, Daniela Paunescu, and Wendelin J. S. Robust chemical preservation of digital information on DNA in silica with error-correcting codes. *Angewandte Chemie International Edition*, 54(8):2552–2555, 2015.
- [20] R. Heckel, G. Mikutis, and R. N. Grass. A characterization of the DNA data storage channel. *Scientific reports*, 9(1):1–12, 2019.

- [21] H. M. Kiah, G. J. Puleo, and O. Milenkovic. Codes for DNA sequence profiles. *IEEE Transactions on Information Theory*, 62(6):3125–3146, 2016.
- [22] M. Kovačević and V. Y. F. Tan. Codes in the space of multisets – coding for permutation channels with impairments. *IEEE Transactions on Information Theory*, 64(7):5156–5169, 2018.
- [23] A. Lenz, P. H. Siegel, A. Wachter-Zeh, and E. Yaakobi. Anchor-based correction of substitutions in indexed sets. In *IEEE International Symposium on Information Theory*, pages 757–761. IEEE, 2019.
- [24] A. Lenz, P. H. Siegel, A. Wachter-Zeh, and E. Yaakobi. Coding over sets for DNA storage. *IEEE Transactions on Information Theory*, 66(4):2331–2351, 2019.
- [25] A. Lenz, P. H. Siegel, A. Wachter-Zeh, and E. Yaakobi. An upper bound on the capacity of the DNA storage channel. In *IEEE Information Theory Workshop*, pages 1–5. IEEE, 2019.
- [26] A. Lenz, P. H. Siegel, A. Wachter-Zeh, and E. Yaakobi. Achieving the capacity of the DNA storage channel. In *IEEE International Conference on Acoustics, Speech and Signal Processing*, pages 8846–8850. IEEE, 2020.
- [27] A. Lenz, L. Welter, and S. Puchinger. Achievable rates of concatenated codes in DNA storage under substitution errors. In *International Symposium on Information Theory and Its Applications*, pages 269–273. IEEE, 2020.
- [28] A. W. Marshall, I. Olkin, and B. C. Arnold. *Inequalities: Theory of majorization and its applications*, volume 143. Springer, 1979.
- [29] K. Marton. A simple proof of the blowing-up lemma. *IEEE Transactions on Information Theory*, 32(3):445–446, 1986.
- [30] K. Marton. Bounding \bar{d} -distance by informational divergence: A method to prove measure concentration. *Annals of probability*, 24(2):857–866, 1996.
- [31] N. Merhav. Statistical physics and information theory. *Foundations and Trends in Communications and Information Theory*, 6(1-2):1–212, 2009.
- [32] M. Mitzenmacher. On the theory and practice of data recovery with multiple versions. In *IEEE International Symposium on Information Theory*, pages 982–986. IEEE, 2006.
- [33] M. Mitzenmacher and E. Upfal. *Probability and computing: Randomization and probabilistic techniques in algorithms and data analysis*. Cambridge University Press, 2017.
- [34] M. S. Neiman. Some fundamental issues of microminiaturization. *Radiotekhnika*, 1(1):3–12, 1964.
- [35] L. Organick, S. D. Ang, Y. Chen, R. Lopez, S. Yekhanin, K. Makarychev, M. Z. Racz, G. Kamath, P. Gopalan, and B. Nguyen. Random access in large-scale DNA data storage. *Nature biotechnology*, 36(3):242–248, 2018.
- [36] Y. Polyanskiy and Y. Wu. Wasserstein continuity of entropy and outer bounds for interference channels. *IEEE Transactions on Information Theory*, 62(7):3992–4002, 2016.
- [37] M. Raginsky and I. Sason. *Concentration of Measure Inequalities in Information Theory, Communications, and Coding*, volume 10. Now Foundations and Trends, 2013.
- [38] F. Sala, R. Gabrys, C. Schoeny, and L. Dolecek. Exact reconstruction from insertions in synchronization codes. *IEEE Transactions on Information Theory*, 63(4):2428–2445, 2017.
- [39] J. Sayir. Codes for efficient data storage on DNA molecules. In *Talk at Inform., Inference, and Energy symposium, Cambridge, U.K.*, 2016.
- [40] I. Shomorony and R. Heckel. DNA-based storage: Models and fundamental limits. *IEEE Transactions on Information Theory*, 67(6):3675–3689, 2021.
- [41] J. Sima, N. Raviv, and J. Bruck. On coding over sliced information. *IEEE Transactions on Information Theory*, 67(5):2793–2807, 2021.
- [42] W. Song, K. Cai, and K. A. S. Immink. Sequence-subset distance and coding for error control in DNA-based data storage. *IEEE Transactions on Information Theory*, 66(10):6048–6065, 2020.
- [43] Y. Tang and F. Farnoud. Error-correcting codes for noisy duplication channels. *IEEE Transactions on Information Theory*, 67(6):3452–3463, 2021.

- [44] D. Tse and P. Viswanath. *Fundamentals of wireless communication*. Cambridge University Press, 2005.
- [45] S. M. H. T. Yazdi, Y. Yuan, J. Ma, H. Zhao, and O. Milenkovic. A rewritable, random-access DNA-based storage system. *Scientific reports*, 5(1):1–10, 2015.
- [46] Z. Zhang. Estimating mutual information via Kolmogorov distance. *IEEE Transactions on Information Theory*, 53(9):3280–3282, 2007.